

PRODUCT CATALOGUE

PRODUCT CATALOGUE

CRITICAL CARE

ANGIOGRAPHY & CATH-LAB

SURGERY

BIOMETRIX CPT

Hoeksteen 11 P.O.B. 7191 | 4815 PR Breda, The Netherlands
Tel: 31-76-5422720 | Fax: 31-76-5422716
sales@biometrixmedical.com | www.biometrixmedical.com

COMPANY OVERVIEW

Biometrix is a medical device company and a leading developer, manufacturer of high-quality medical devices that meets the clinical demands of several critical care procedures.

Biometrix has been successfully serving the medical community for 25 years and is currently selling in over 50 countries worldwide.

By continually improving our existing product lines Biometrix is capable of providing ergonomic and cost saving bedside solutions. Patients, physicians and nurses around the globe can rely on Biometrix solutions and products.

Biometrix's strong personal relationships within the medical community's decision makers, further strengthens the company's competitive position and facilitates its continuously growing customer base alongside returning customers. The company provides reliable solutions for operating rooms, cardio-thoracic, intensive care, and interventional cardiology and angiography units.

COMPANY HIGHLIGHTS

Global presence:

Europe, Far & Middle East, Latin America, Africa

Business:

Selected product lines for Critical Care, Surgery, Angiography and Cath-Lab.

Quality management:

ISO9001:2008, ISO13485:2003 certified; FDA registered; CE marked products, per Annex II of Medical Devices Directive

93/43/EEC as amended per 2007/47/EC

CRITICAL CARE

CENTRA-LINE™

Central Venous Catheter Sets

Custom CVC Pack

Rapid Infusion Catheter Sets

Table Conversion: French, Millimeters, Gauge, Inches

HEMO-ACCESS™

Hemo Dialysis Catheter Sets

ART-LINE™

Invasive Blood Pressure Monitoring Systems

Closed System Invasive Blood Pressure Monitoring Systems

Adapting Cables and Accessories

Pressure Monitoring Lines

Arterial Catheter Sets

URIMETRIX™

Urine Drainage Systems

Foley Catheters with Temperature Sensor

Intra-Abdominal Pressure Monitoring Set (IAP)

INFU-LINE™

Manifolds, Stopcocks, IV Lines

Nutrition Filter Sets

IV Lines for Photosensitive Medication

CENTRA-LINE™ Adult

Biometrix offers a broad range of catheter kits and trays for central vein insertion. We provide safe and reliable devices for a wide variety of clinical interventions.

Central Venous Catheter Sets

4 Lumen Catheter Sets

Code	Description	Flow Rate (ml/min)			
		Distal	Proximal	Medial 1	Medial 2
HH-8515	4 Lumen, 8.5Fr x 15cm	59	31	95	27
HH-8516*	4 Lumen, 8.5Fr x 15cm	59	31	95	27
HH-8520	4 Lumen, 8.5Fr x 20cm	57	26	90	26
HH-8521*	4 Lumen, 8.5Fr x 20cm	57	26	90	26
HH-8530	4 Lumen, 8.5Fr x 30cm	45	19	73	18

Qty/Box: 20

Catheter Tray Contents

- Radiopaque PU Catheter ● 0.032" Marked Guidewire J-Flex Tip
- 18Ga x 7cm Introducer Needle ● Vessel Dilator ● Scalpel ● 5ml Syringe ● Heparin Locks
- (*) HH-8516, HH-8521 contains a 0.035" Special Kink Resistant Guidewire

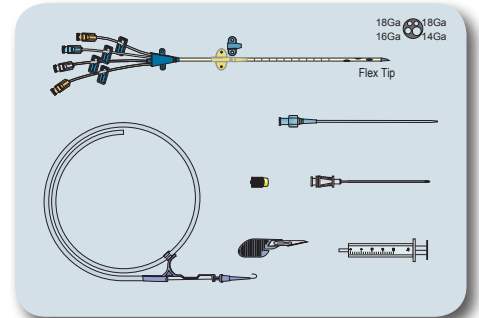

4 Lumen Catheter Sets with Y-Introducer Needle

Code	Description	Flow Rate (ml/min)			
		Distal	Proximal	Medial 1	Medial 2
HH-I8515	4 Lumen, 8.5Fr x 15cm	59	31	95	27
HH-I8520	4 Lumen, 8.5Fr x 20cm	57	26	90	26
HH-I8530	4 Lumen, 8.5Fr x 30cm	45	19	73	18

Qty/Box: 20

Catheter Tray Contents

- Radiopaque PU Catheter ● 0.032" Marked Guidewire J-Flex Tip
- 18Ga x 7cm Y-Introducer Needle ● Vessel Dilator ● Scalpel ● 5ml Syringe
- Heparin Locks

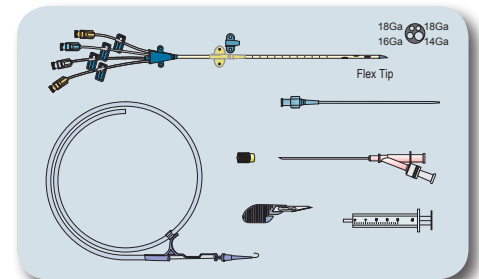

4 Lumen Catheter Sets with Needle-Free Valves and Y-Introducer Needle

Code	Description	Flow Rate (ml/min)			
		Distal	Proximal	Medial 1	Medial 2
HH-E8515	4 Lumen, 8.5Fr x 15cm	59	31	95	27
HH-E8516*	4 Lumen, 8.5Fr x 15cm	59	31	95	27
HH-E8520	4 Lumen, 8.5Fr x 20cm	57	26	90	26
HH-E8521*	4 Lumen, 8.5Fr x 20cm	57	26	90	26
HH-E8530	4 Lumen, 8.5Fr x 30cm	45	19	73	18

Qty/Box: 20

Catheter Tray Contents

- Radiopaque PU Catheter ● 0.032" Marked Guidewire J-Flex Tip
- 18Ga x 7cm Y-Introducer Needle ● Vessel Dilator ● Scalpel ● 5ml Syringe
- 2 CLC2000® Needle-free Valve ● 1 Clave® Needle-free Valve
- (*) HH-E8516, HH-E8521 contains a 0.035" Special Kink Resistant Guidewire

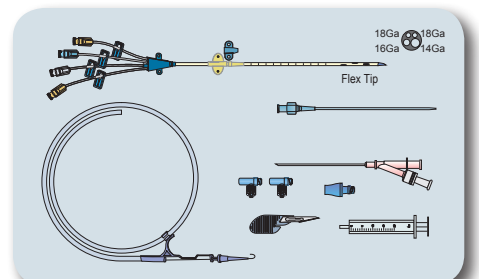

Central Venous Catheter Sets

3 Lumen Catheter Sets

Code	Description	Flow Rate (ml/min)		
		Distal	Proximal	Medial 1
HJ-7015	3 Lumen, 7Fr x 15cm	64	33	30
HJ-7016*	3 Lumen, 7Fr x 15cm	64	33	30
HJ-7020	3 Lumen, 7Fr x 20cm	52	26	24
HJ-7021*	3 Lumen, 7Fr x 20cm	52	26	24
HJ-7030	3 Lumen, 7Fr x 30cm	41	17	18
HJ-X7015	3 Lumen, 7.5Fr x 15cm	72	37	34
HJ-X7020	3 Lumen, 7.5Fr x 20cm	58	33	31
HJ-X7030	3 Lumen, 7.5Fr x 30cm	46	26	25

Qty/Box: 20

Catheter Tray Contents

- Radiopaque PU Catheter ● 0.032" Marked Guidewire J-Flex Tip
 - 18Ga x 7cm Introducer Needle ● Vessel Dilator ● Scalpel
 - 5ml Syringe ● Heparin Locks
- (*) HJ-7016, HJ-7021 contains a 0.035" Special Kink Resistant Guidewire

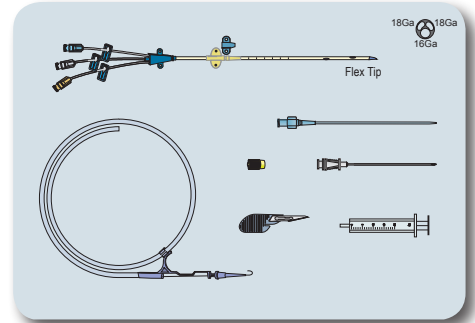

3 Lumen Catheter Sets with Y-Introducer Needle

Code	Description	Flow Rate (ml/min)		
		Distal	Proximal	Medial 1
HJ-I7015	3 Lumen, 7.5Fr x 15cm	72	37	34
HJ-I7020	3 Lumen, 7.5Fr x 20cm	58	33	31
HJ-I7030	3 Lumen, 7.5Fr x 30cm	46	26	25

Qty/Box: 20

Catheter Tray Contents

- Radiopaque PU Catheter ● 0.032" Marked Guidewire J-Flex Tip
- 18Ga x 7cm Y-Introducer Needle ● Vessel Dilator ● Scalpel ● 5ml Syringe
- Heparin Locks

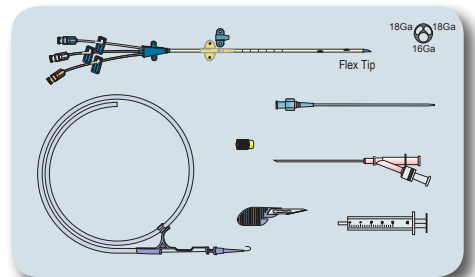

3 Lumen Catheter Sets with Needle-Free Valves and Y-Introducer Needle

Code	Description	Flow Rate (ml/min)		
		Distal	Proximal	Medial 1
HJ-E7015	3 Lumen, 7.5Fr x 15cm	72	37	34
HJ-E7016*	3 Lumen, 7.5Fr x 15cm	72	37	34
HJ-E7020	3 Lumen, 7.5Fr x 20cm	58	33	31
HJ-E7021*	3 Lumen, 7.5Fr x 20cm	58	33	31
HJ-E7030	3 Lumen, 7.5Fr x 30cm	46	26	25
HJ-E7031*	3 Lumen, 7.5Fr x 30cm	46	26	25

Qty/Box: 20

Catheter Tray Contents

- Radiopaque PU Catheter ● 0.032" Marked Guidewire J-Flex Tip
 - 18Ga x 7cm Y-Introducer Needle ● Vessel Dilator ● Scalpel ● 5ml Syringe
 - 2 CLC2000® Needle-Free Valve ● 1 Clave® Needle-free Valve
- (*) HJ-E7016, HJ-E7021, HJ-E7031 contains a 0.035" Special Kink Resistant Guidewire

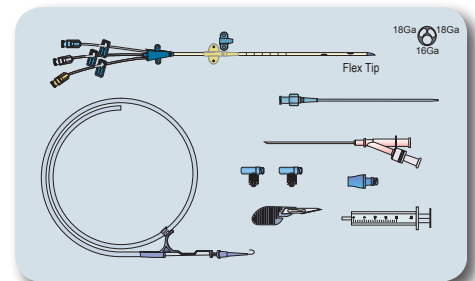

CENTRA-LINE™ Adult

Central Venous Catheter Sets

2 Lumen Catheter Sets

Code	Description	Flow Rate (ml/min)	
		Distal	Proximal
HK-7015	2 Lumen, 7Fr x 15cm	91	70
HK-7016*	2 Lumen, 7Fr x 15cm	91	70
HK-7020	2 Lumen, 7Fr x 20cm	85	54
HK-7021*	2 Lumen, 7Fr x 20cm	85	54
HK-7030	2 Lumen, 7Fr x 30cm	66	44
HK-X7015	2 Lumen, 7.5Fr x 15cm	113	63
HK-X7020	2 Lumen, 7.5Fr x 20cm	108	51
HK-X7030	2 Lumen, 7.5Fr x 30cm	85	36

Qty/Box: 20

Catheter Tray Contents

- Radiopaque PU Catheter ● 0.032" Marked Guidewire J-Flex Tip
 - 18Ga x 7cm Introducer Needle ● Vessel Dilator ● Scalpel ● 5ml Syringe
 - Heparin Locks
- (*) HK-7016, HK-7021 contains a 0.035" Special Kink Resistant Guidewire

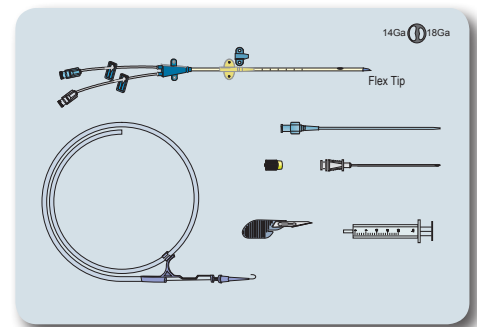

2 Lumen Catheter Sets with Y-Introducer Needle

Code	Description	Flow Rate (ml/min)	
		Distal	Proximal
HK-I7015	2 Lumen, 7.5Fr x 15cm	113	63
HK-I7020	2 Lumen, 7.5Fr x 20cm	108	51
HK-I7030	2 Lumen, 7.5Fr x 30cm	85	36

Qty/Box: 20

Catheter Tray Contents

- Radiopaque PU Catheter ● 0.032" Marked Guidewire J-Flex Tip
- 18Ga x 7cm Y-Introducer Needle ● Vessel Dilator ● Scalpel ● 5ml Syringe
- Heparin Locks

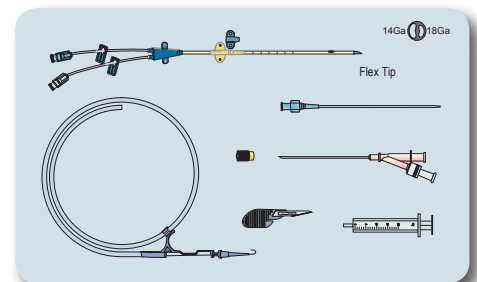

2 Lumen Catheter Sets with Needle-Free Valves and Y-Introducer Needle

Code	Description	Flow Rate (ml/min)	
		Distal	Proximal
HK-E7015	2 Lumen, 7.5Fr x 15cm	113	63
HK-E7016*	2 Lumen, 7.5Fr x 15cm	113	63
HK-E7020	2 Lumen, 7.5Fr x 20cm	108	51
HK-E7021*	2 Lumen, 7.5Fr x 20cm	108	51
HK-E7030	2 Lumen, 7.5Fr x 30cm	85	36

Qty/Box: 20

Catheter Tray Contents

- Radiopaque PU Catheter ● 0.032" Marked Guidewire J-Flex Tip
 - 18Ga x 7cm Y-Introducer Needle ● Vessel Dilator ● Scalpel ● 5ml Syringe
 - 1 CLC2000® Needle-Free Valve ● 1 Clave® Needle-free Valve
- (*) HK-E7016, HK-E7021 contains a 0.035" Special Kink Resistant Guidewire

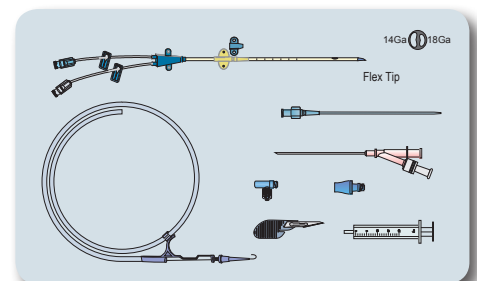

Central Venous Catheter Sets

1 Single Lumen Catheter Sets

Code	Description	Flow Rate (ml/min)	
		Distal	
HO-4015	1 Lumen, 14Ga x 15cm	144	
HO-4020	1 Lumen, 14Ga x 20cm	127	
HO-4030	1 Lumen, 14Ga x 30cm	112	
HO-6015	1 Lumen, 16Ga x 15cm	67	
HO-6020	1 Lumen, 16Ga x 20cm	56	
HO-6030	1 Lumen, 16Ga x 30cm	48	
HO-8015	1 Lumen, 18Ga x 15cm	36	
HO-8020	1 Lumen, 18Ga x 20cm	30	

Qty/Box: 20 HO-8015 & HO-8020: 10

HO-40xx, HO-60xx Catheter Tray Contents

- Radiopaque PU Catheter ● 0.032" Marked Guidewire J-Flex Tip
- 18Ga x 7cm Introducer Needle ● Vessel Dilator ● Scalpel
- 5ml Syringe ● Heparin Locks

HO-8015, HO-8020 Catheter Tray Contents

- Radiopaque PU Catheter ● 0.025" Marked Guidewire J-Flex Tip
- 20Ga x 4cm Introducer Needle ● Vessel Dilator ● Scalpel
- 5ml Syringe ● Heparin Locks

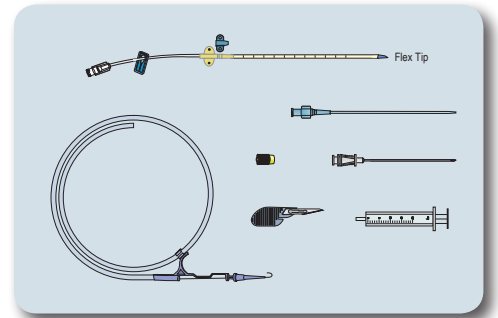

1 Single Lumen Catheter Sets with Y-Introducer Needle

Code	Description	Flow Rate (ml/min)	
		Distal	
HO-I4015	1 Lumen, 14Ga x 15cm	144	
HO-I4020	1 Lumen, 14Ga x 20cm	127	
HO-I4030	1 Lumen, 14Ga x 30cm	112	
HO-I6015	1 Lumen, 16Ga x 15cm	67	
HO-I6020	1 Lumen, 16Ga x 20cm	56	
HO-I6030	1 Lumen, 16Ga x 30cm	48	

Qty/Box: 20

Catheter Tray Contents

- Radiopaque PU Catheter ● 0.032" Marked Guidewire J-Flex Tip ● 18Ga x 7cm Y-Introducer Needle ● Vessel Dilator ● Scalpel ● 5ml Syringe ● Heparin Locks

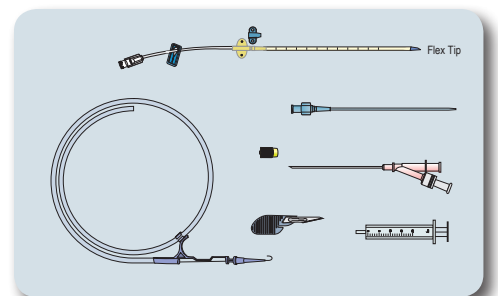

1 Single Lumen Catheter Sets with Needle-Free Valves and Y-Introducer Needle

Code	Description	Flow Rate ml/min	
		Distal	
HO-E4015	1 Lumen, 14Ga x 15cm	144	
HO-E4020	1 Lumen, 14Ga x 20cm	127	
HO-E4030	1 Lumen, 14Ga x 30cm	112	
HO-E6015	1 Lumen, 16Ga x 15cm	67	
HO-E6020	1 Lumen, 16Ga x 20cm	56	
HO-E6030	1 Lumen, 16Ga x 30cm	48	

Qty/Box: 20

Catheter Tray Contents

- Radiopaque PU Catheter ● 0.032" Marked Guidewire J-Flex Tip
- 18Ga x 7cm Y-Introducer Needle ● Vessel Dilator ● Scalpel ● 5ml Syringe
- 1 CLC2000® Needle-Free Valve

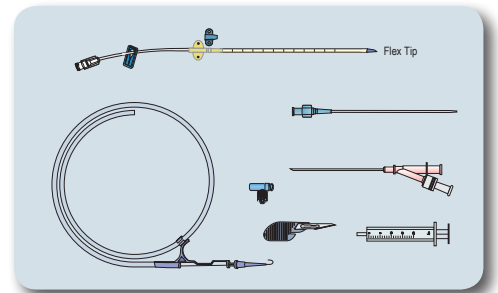

CENTRA-LINE™ Adult

Central Venous Catheter Sets

Hubless 14Ga Single-Lumen Catheter set

Code	Description
HG-4015	1 Lumen, 14Ga x 15cm
HG-4020	1 Lumen, 14Ga x 20cm
HG-4030	1 Lumen, 14Ga x 30cm

Qty/Box: 20

Catheter Tray Contents

- Radiopaque PU Catheter 14Ga w/o hub
- 0.032" Marked Guidewire J-Flex Tip
- 18Ga x 7cm Introducer Needle
- Vessel Dilator
- Heparin Locks

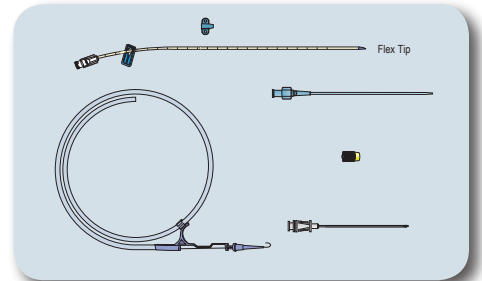

Hubless 16Ga Single-Lumen Catheter set

Code	Description
HG-6015	1 Lumen, 16Ga x 15cm
HG-6020	1 Lumen, 16Ga x 20cm
HG-6030	1 Lumen, 16Ga x 30cm

Qty/Box: 20

Catheter Tray Contents

- Radiopaque PU Catheter 16Ga w/o hub
- 0.032" Marked Guidewire J-Flex Tip
- 18Ga x 7cm Introducer Needle
- Vessel Dilator
- Heparin Locks

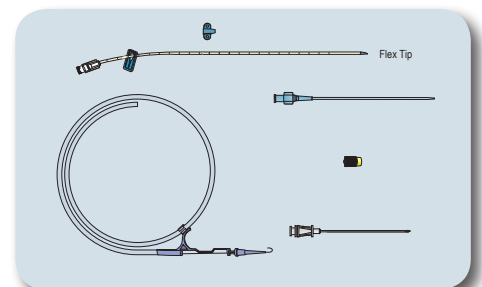

Hubless 18Ga Single-Lumen Catheter set

Code	Description
HG-8015	1 Lumen, 18Ga x 15cm
HG-8020	1 Lumen, 18Ga x 20cm
HG-8030	1 Lumen, 18Ga x 30cm

Qty/Box: 20

Catheter Tray Contents

- Radiopaque PU Catheter 18Ga w/o hub
- 0.025" Marked Guidewire J-Flex Tip
- 20Ga x 4cm Introducer Needle
- Vessel Dilator
- Heparin Locks

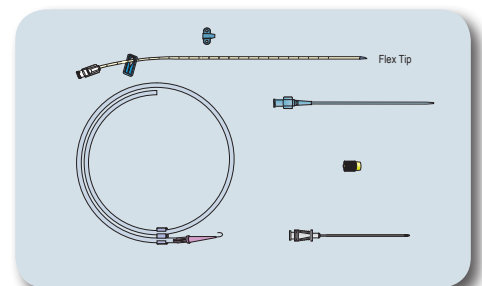

Central Venous Catheter Sets

3 Lumen Catheters Sets

Code	Description	Flow Rate (ml/min)		
		Distal	Proximal	Medial 1
HJ-5008	3 Lumen, 5.5Fr x 8cm	25	18	18
HJ-5013	3 Lumen, 5.5Fr x 13cm	21	13	13
HJ-5030	3 Lumen, 5.5Fr x 30cm	18	8	8

Qty/Box: 10

Catheter Tray Contents

- Radiopaque PU Catheter ● 0.018" Marked Guidewire J-Flex Tip
- 21Ga x 3.8cm Introducer Needle ● Vessel Dilator ● Scalpel ● 5ml Syringe ● Heparin Locks

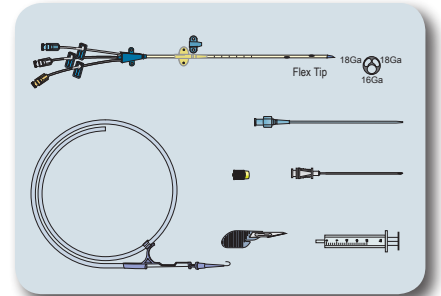

3 Multi-Lumen Catheter Sets with Needle-Free Valves

Code	Description	Flow Rate (ml/min)		
		Distal	Proximal	Medial 1
HJ-E5008	3 Lumen, 5.5Fr x 8cm	25	18	18
HJ-E5013	3 Lumen, 5.5Fr x 13cm	21	13	13
HJ-E5030	3 Lumen, 5.5Fr x 30cm	18	8	8

Qty/Box: 10

Catheter Tray Contents

- Radiopaque PU Catheter ● 0.018" Marked Guidewire J-Flex Tip
- 21Ga x 3.8cm Introducer Needle ● Vessel Dilator ● Scalpel ● 5ml Syringe
- 2 CLC2000® Needle-Free Valve ● 1 Clave® Needle-free Valve

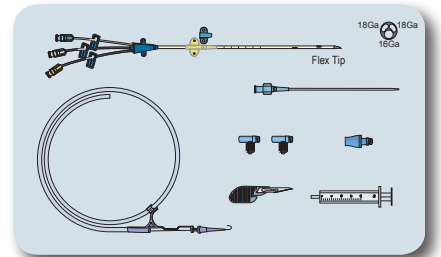

CENTRA-LINE™ Pediatric

Central Venous Catheter Sets

2 Lumen Catheters Sets

Code	Description	Flow Rate (ml/min)	
		Distal	Proximal
HK-4005	2 Lumen, 4Fr x 5cm	27	22
HK-4008	2 Lumen, 4Fr x 8cm	26	18
HK-4013	2 Lumen, 4Fr x 13cm	22	12
HK-4030	2 Lumen, 4Fr x 30cm	10	6
HK-5006	2 Lumen, 5Fr x 6cm	38	45
HK-5008	2 Lumen, 5Fr x 8cm	36	36
HK-5013	2 Lumen, 5Fr x 13cm	30	22
HK-5020	2 Lumen, 5Fr x 20cm	26	18

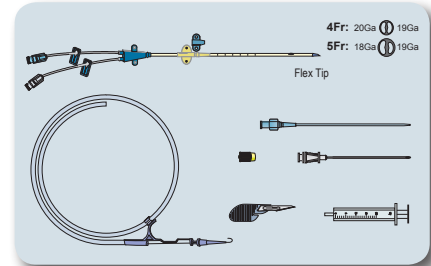

Catheter Tray Contents

Qty/Box: 10

- Radiopaque PU Catheter ● 0.018" Marked Guidewire J-Flex Tip
- 21Ga x 3.8cm Introducer Needle ● Vessel Dilator ● Scalpel ● 5ml Syringe ● Heparin Locks

2 Lumen Catheter Sets with Needle-Free Valves

Code	Description	Flow Rate (ml/min)	
		Distal	Proximal
HK-E4005	2 Lumen, 4Fr x 5cm	27	22
HK-E4008	2 Lumen, 4Fr x 8cm	26	18
HK-E4013	2 Lumen, 4Fr x 13cm	22	12
HK-E5006	2 Lumen, 5Fr x 6cm	38	45
HK-E5008	2 Lumen, 5Fr x 8cm	36	36
HK-E5013	2 Lumen, 5Fr x 13cm	30	22

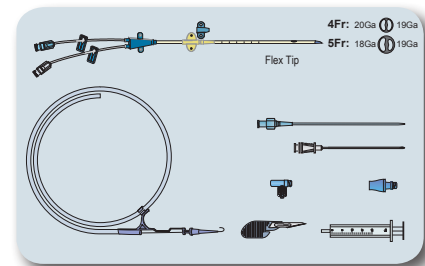

Qty/Box: 10

Catheter Tray Contents

- Radiopaque PU Catheter ● 0.018" Marked Guidewire J-Flex Tip
- 21Ga x 3.8cm Introducer Needle ● Vessel Dilator ● Scalpel ● 5ml Syringe
- 1 CLC2000® Needleless Valve ● 1 Clave® Needle-free Valve

1 Single Lumen Catheters Sets

Code	Description	Flow Rate (ml/min)
		Distal
HO-9010*	1 Lumen, 20Ga x 10cm	21
HO-9013*	1 Lumen, 20Ga x 13cm	19
HO-9015*	1 Lumen, 20Ga x 15cm	18
HO-9020*	1 Lumen, 20Ga x 20cm	16
HO-7008	1 Lumen, 24Ga x 8cm	10
HO-7015	1 Lumen, 24Ga x 15cm	9
HO-7020	1 Lumen, 24Ga x 20cm	8

Qty/Box: 10

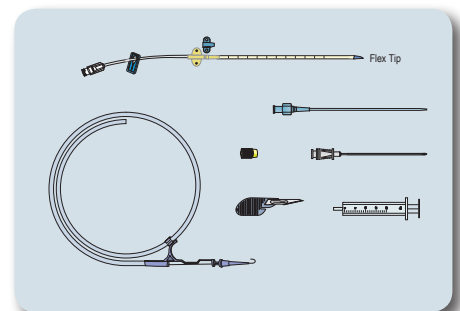

HO-7008, HO-7015, HO-7020 Catheter Tray Contents

- Radiopaque PU Catheter ● 0.018" Marked Guidewire J-Flex Tip ● 20Ga x 4cm Introducer Needle ● Vessel Dilator ● Scalpel ● 5ml Syringe ● Heparin Locks
- (*) HO-9010, HO-9013, HO-9015, HO-9020 contains a 0.021" Marked Guidewire J-Flex Tip

Custom CVC Pack

Biometrix is pleased to offer a complete CVC tray. This new tray is based on our variety of Centra-Line™ central vein catheters and offers the opportunity to add to the catheter sets a complete range of components such as patient draping, sutures, needle counters, forceps, gauze sponges, extension sets and stopcocks.

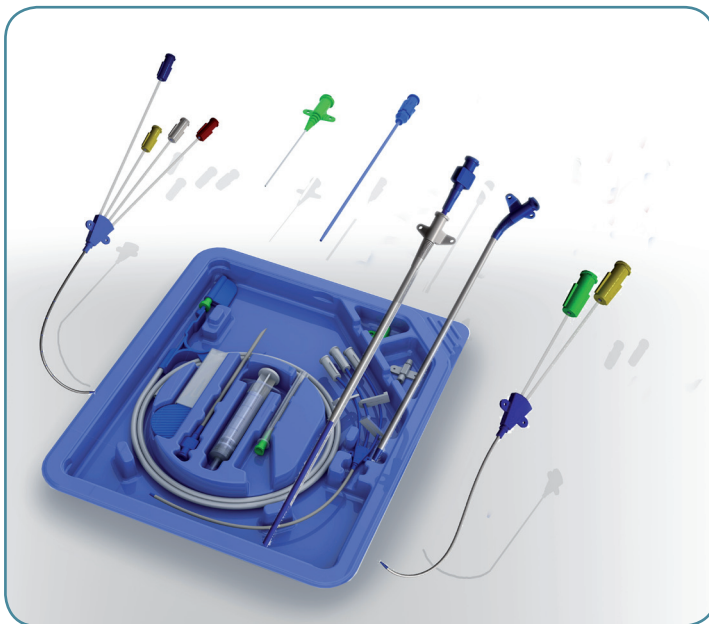

Optional Additional Catheter Tray Components:

- patient draping
- sutures
- needle counters
- forceps
- gauze sponges
- extension sets
- stopcocks
- gowns
- bowls/cups
- sponge sticks
- dressing
- securements
- needle free valves

Hemostatic Valve Introducer Sets for Thermodilution Catheters

Code	Description
HD-4441	6Fr
HD-4741	8Fr
HD-4841	8.5Fr

Qty/Box: 10

Catheter Tray Contents

- Sheath Dilator Hemostatic Valve Unit with Side Arm and stopcock
- 0.038" x 50cm Stainless Steel Guidewire
- 18Ga x 7cm Introducer Needle
- 80cm Repositioning Sleeve
- 5cc Syringe

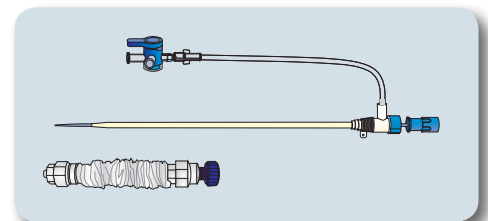

Rapid Infusion Sets

Biometrix Rapid Infusion Catheter Systems provide a safe and efficient solution during trauma cases. Biometrix offers a few versions of Rapid Infusion Catheters Access Systems.

Rapid Infusion Catheter

Code	Description
JD-X4062	8Fr Rapid Infusion Catheter Set

Qty/Box: 10

Tray Contents

- 8Fr Catheter Sheath and Dilator Assembly
- 0.035" Marked Guidewire J-Flex Tip
- 20cm High Flow Line with Large Bore stopcock
- 18Ga x 7cm Introducer Needle
- 5ml Syringe

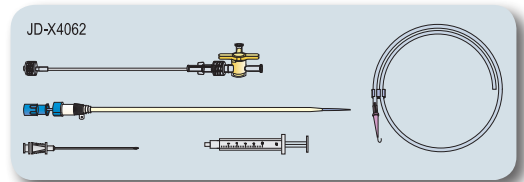

Customized sets available

Rapid Infusion Set

Code	Description
CG-0110	Supertrans Y-Type

Qty/Box: 25

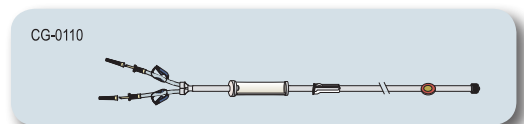

Rapid Infusion Pack

Code	Description
JC-7100	Trauma Pack 8Fr

Qty/Box: 10

Tray Contents

- 8Fr Catheter Sheath and Dilator Assembly
- 0.035" Marked Guidewire J-Flex Tip
- High Flow Infusion Set
- 14Ga over-the-needle Catheter
- 18Ga x 7cm Introducer Needle
- 4 Way Large Bore Stopcock
- 5ml Syringe

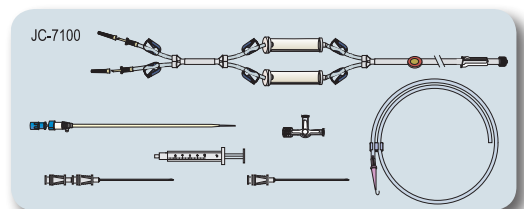

Biometrix Hemodialysis Catheters are designed for temporary use for dialysis and hemofiltration in subclavian, jugular and femoral veins.

Dialysis Catheters for Subclavian and Femoral Approach

3 Lumen Catheter Sets

Code	Description
EG-7613	12Fr x 15 cm
EG-7713	12Fr x 20 cm

Qty/Box: 10

Catheter Tray Contents

- Radiopaque PU Catheter
- 0.035" Marked Guidewire J-Flex Tip
- 18Ga x 7cm Introducer Needle
- 2 Vessel Dilators
- 5ml Syringe
- Heparin Locks

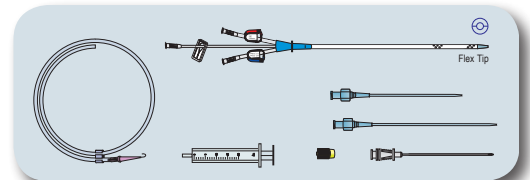

2 Lumen Catheter Sets

Code	Description
EF-7613	12Fr x 15 cm
EF-7713	12Fr x 20 cm
EF-7813	12Fr x 24 cm

Qty/Box: 10

Catheter Tray Contents

- Radiopaque PU Catheter
- 0.038" Marked Guidewire J-Flex Tip
- 18Ga x 7cm Introducer Needle
- 2 Vessel Dilators
- 5ml Syringe
- Heparin Locks

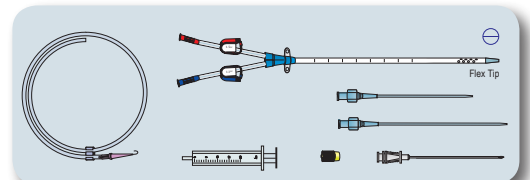

2 Lumen Catheter Sets Rigid Tip Version

Code	Description
EF-9613	11Fr x 15 cm
EF-9713	11Fr x 20 cm

Qty/Box: 10

Catheter Tray Contents

- Radiopaque PU Catheter
- 0.035" Special Kink Resistant Guidewire
- 18Ga x 7cm Introducer Needle
- 2 Vessel Dilators
- 5ml Syringe
- Heparin Locks

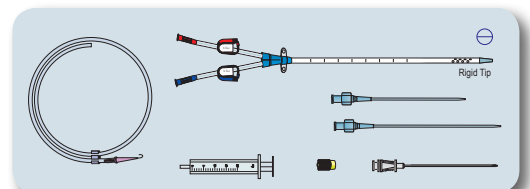

1 Single Lumen Catheter Sets

Code	Description
EI-1443	8Fr x 15 cm Y-Type
EI-2053	8Fr x 20 cm Y-Type
EH-1443	8Fr x 15 cm Straight
EH-2053	8Fr x 20 cm Straight

Qty/Box: 10

Catheter Tray Contents

- Radiopaque PU Catheter
- 0.035" Marked Guidewire J-Flex Tip
- 18Ga x 7cm Introducer Needle
- Vessel Dilator
- 5ml Syringe
- Heparin Locks

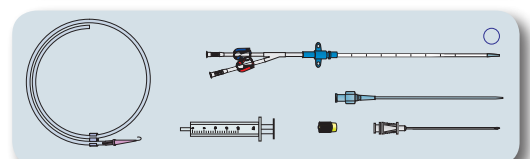
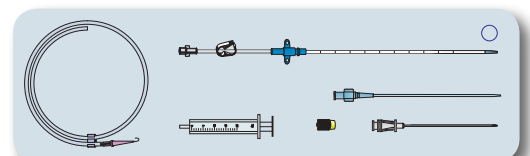

Dialysis Catheters for Internal Jugular Approach

3 Lumen Catheter Sets

Code	Description
EG-7623	12Fr x 15 cm curved extensions
EG-7723	12Fr x 20 cm curved extensions

Qty/Box: 10

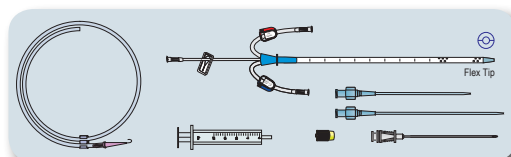

Catheter Tray Contents

- Radiopaque PU Catheter
- 0.035" Marked Guidewire J-Flex Tip
- 18Ga x 7cm Introducer Needle
- 2 Vessel Dilators
- 5ml Syringe
- Heparin Locks

2 Lumen Catheter Sets

Code	Description
EF-7623	12Fr x 15 cm curved extensions
EF-7723	12Fr x 20 cm curved extensions

Qty/Box: 10

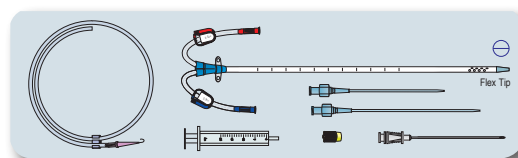

Catheter Tray Contents

- Radiopaque PU Catheter
- 0.038" Marked Guidewire J-Flex Tip
- 18Ga x 7cm Introducer Needle
- 2 Vessel Dilators
- 5ml Syringe
- Heparin Locks

2 Lumen Catheter Sets Rigid Tip Version

Code	Description
EF-9623	11Fr x 15 cm curved extensions
EF-9723	11Fr x 20 cm curved extensions

Qty/Box: 10

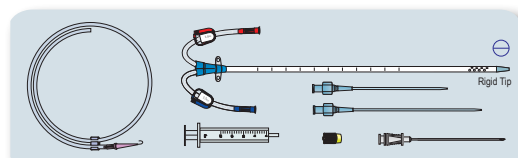

Catheter Tray Contents

- Radiopaque PU Catheter
- 0.035" Special Kink Resistant Guidewire
- 18Ga x 7cm Introducer Needle
- 2 Vessel Dilators
- 5ml Syringe
- Heparin Locks

2 Lumen Catheter Sets Bent

Code	Description
EF-7693	11.5Fr x 15 cm
EF-7793	11.5Fr x 20 cm

Qty/Box: 10

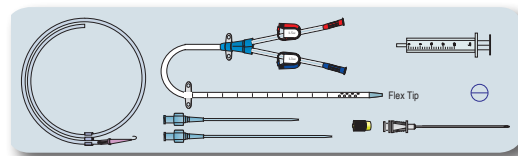

Catheter Tray Contents

- Radiopaque PU Catheter
- 0.038" Marked Guidewire J-Flex Tip
- 18Ga x 7cm Introducer Needle
- 2 Vessel Dilators
- 5ml Syringe
- Heparin Locks

ART-LINE™ Adult

Biometrix offers blood pressure monitoring system that constantly monitors the blood pressure of critically ill patients. This disposable sterile set leads to earlier intervention and restoration of physiological functioning. The sets can be supplied one, two or three channels configuration to fit customer specifications.

Invasive Blood Pressure Monitoring Systems

Art-Line™ Kits Single Channel

Code	Description	Qty/Box
AB-0023	Single Channel	25

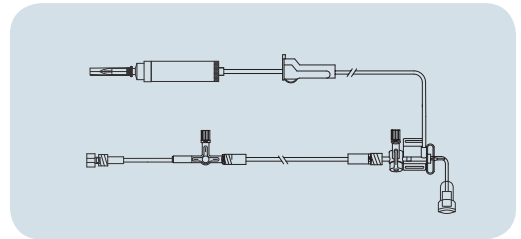

Art-Line™ Kits Single Channel - Red Strip

Code	Description	Qty/Box
AA-0123	Single Channel - Red Strip	25

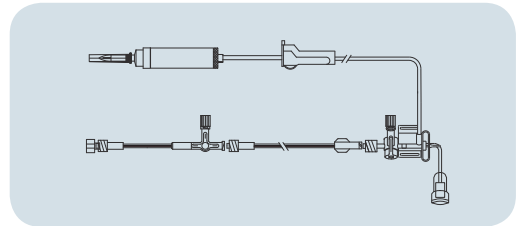

Art-Line™ Kits Double Channel

Code	Description	Qty/Box
AE-0123	Double Channel	20

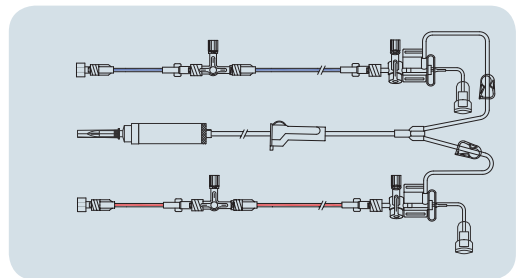

Art-Line™ Kits Triple Channel

Code	Description	Qty/Box
AC-X0123	Triple Channel	10

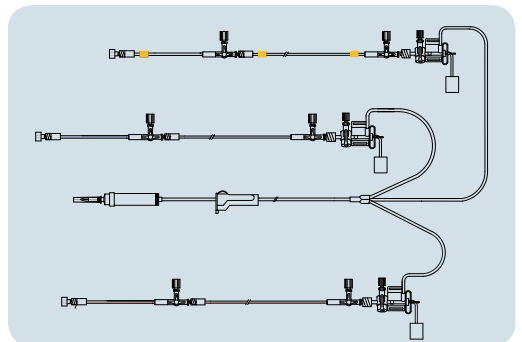

Customized sets available

ART-LINE™ Adult

Biometrix's blood sampling closed system ensures safe and accurate blood sampling, prevents blood loss and minimizes cross contamination risks.

Closed System Invasive Blood Pressure Monitoring Systems

Closed System Art-Line™

Code	Description	Qty/Box
AI-0423	Closed System with Injection Site - Adult	20

The Lab-site provides safe and accurate blood sampling.

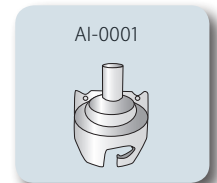
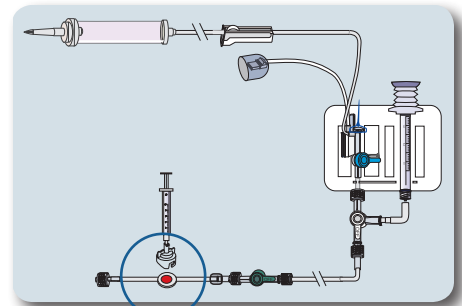
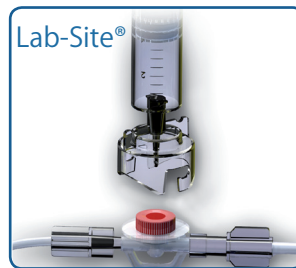

Code	Description	Qty/Box
AI-0001	Needle-free Cannula	50

Closed System Art-Line™ with Marvelous Stopcock

Code	Description	Qty/Box
AI-4423	Closed System Blood Pressure Monitoring Set with Silver-Treated Luer Activated Closed Stopcock	20

The Marvelous stopcock benefits include the added feature of a needle-free, self-flushing, silver-treated, sampling stopcock.

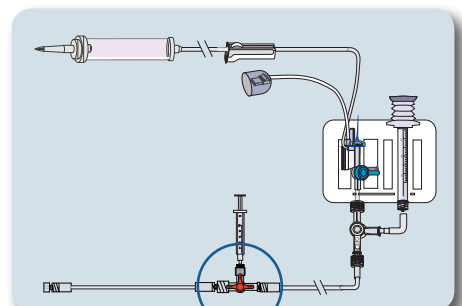
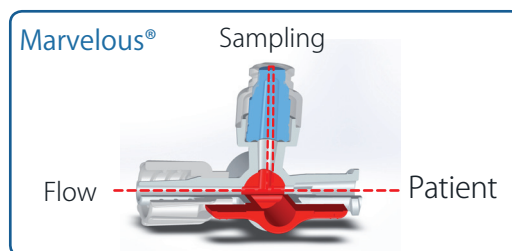

Invasive Blood Pressure Monitoring Systems

Code	Description	Qty/Box
AF-0023	Single Channel Blood Pressure Set with DPT and 3ml Flush Device	20

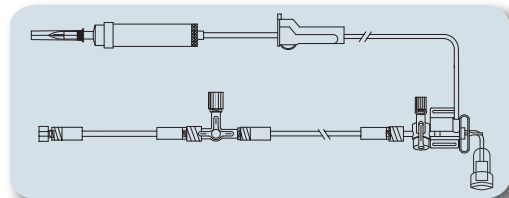

Code	Description	Qty/Box
AF-X0213	Single Channel Blood Pressure Set with DPT and 30ml Flush Device	50

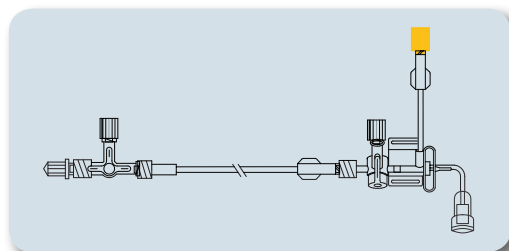

Closed System Invasive Blood Pressure Monitoring Systems

Code	Description	Qty/Box
AI-0123 (*)	Closed System with Injection Site - Pediatric	20

(*) Pediatric Monitoring Line 1 x 2,5 mm

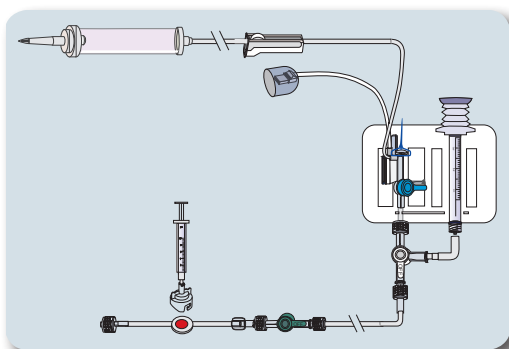

Customized sets available

Accessories

Disposable Blood Pressure Transducer (DPT)

Code	Description
AS-0013	Disposable Blood Pressure Transducer
AS-0023	Disposable Blood Pressure Transducer with 3ml Flush Device

Qty/Box: 25

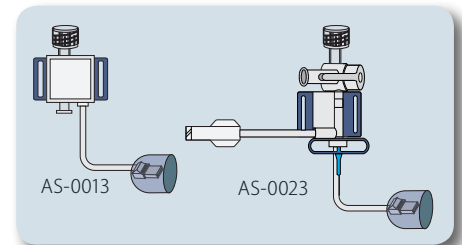

Organizers

Code	Description	Qty/Box
AS-0402	Two Plate DPT Organizer	10
AS-0404	Three Plate DPT Organizer	10
AS-0403	Organizer Holder	1
AT-0300	3ml Flush Device	50

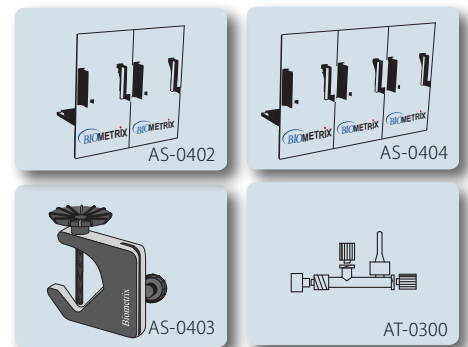

Adapting Cables

Code	Description	Pin structure
ZF-0001	Mennen ~ 6 pins	
ZF-0002	Hewlett Packard ~ 12 pins	
ZF-0005	Datex ~ 10 sockets	
ZF-0007	Datascope ~ 6 sockets	
ZF-0008	Corometrics ~ 12 pins	
ZF-0010	Marquette ~ 11 pins	
ZF-0012	Siemens ~ 6 pins	
ZF-0013	Nihon Kohden ~ 5 pins	
ZF-0016	Drager ~ 10 pins	
ZF-0017	Spacelabs ~ 6 pins	
ZF-0022	Siemens Elema ~ 15 pins	
ZF-0026	Critical Scholar ~ 5 pins	
ZF-0100	Litton/Servomed ~ 10 pins	
ZF-0111	Shiley Stockert ~ 4 pins	
ZF-0112	Kontron ~ 12 pins	
ZF-0213	Nihon Kohden ~ 14 pins	
ZF-0250	Schiller ~ 5 pins	
ZF-1828	Siemens ~ 7 pins	

Qty/Box: 1

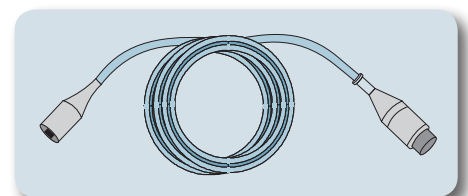

Pressure Monitoring Lines

Pressure Lines Adult

Code	Description	Qty/Box
AH-1015	15 cm M/F	150
AH-1030	30 cm M/F	150
AH-1050	50 cm M/F	150
AH-1100	100 cm M/F	150
AH-1150	150 cm M/F	100
AH-1180	180 cm M/F	100
AH-1200	200 cm M/F	100
AH-2100	100 cm M/M	150
AH-2200	200 cm M/M	100
AM-4015	15 cm with 4 Way Stopcock	100
AM-4050	50 cm with 4 Way Stopcock	100
AM-4100	100 cm with 4 Way Stopcock	100

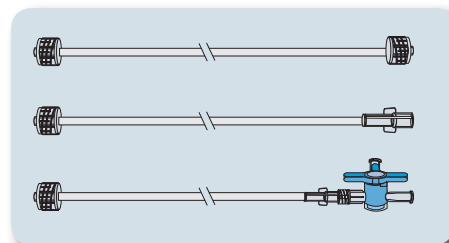

Color-coded lines are available

Pressure Lines Pediatric

Code	Description	Qty/Box
AK-1015	15 cm M/F	150
AK-1050	50 cm M/F	150
AK-1100	100 cm M/F	150
AK-1150	150 cm M/F	150
AK-1200	200 cm M/F	100
AK-2300	300 cm M/M	100
AN-4015	15 cm Line with 4 Way Stopcock	100

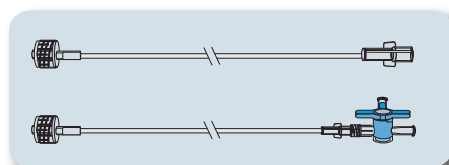

Arterial Catheter Sets

Code	Description	Qty/Box
HP-1822	18Ga x 8cm	10
HP-1841	18Ga x 12cm	10

Set Contents

- 18Ga Radiopaque Arterial Catheter
- 0.035" x 50cm Marked Guidewire J-Flex Tip
- 18Ga x 7cm Introducer Needle ● 5ml Syringe ● Scalpel

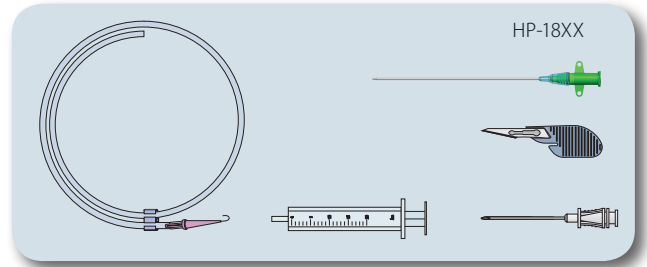

Code	Description	Qty/Box
HP-2000	20Ga x 4.5cm	10
HP-2022	20Ga x 8cm	10

Set Contents

- 20Ga Radiopaque Arterial Catheter
- 0.021" x 20cm Straight Guidewire
- 20Ga x 4cm Introducer Needle ● 3ml Syringe

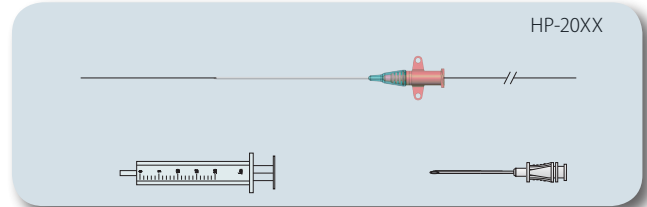

Customized sets available

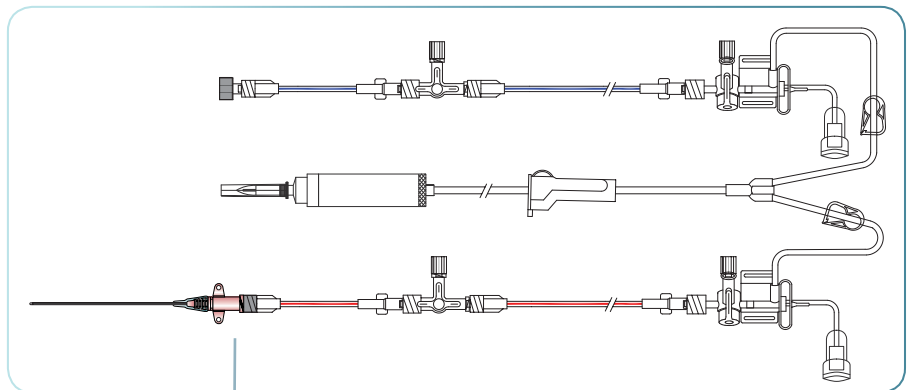

Arterial Catheter

Art-Line Kits

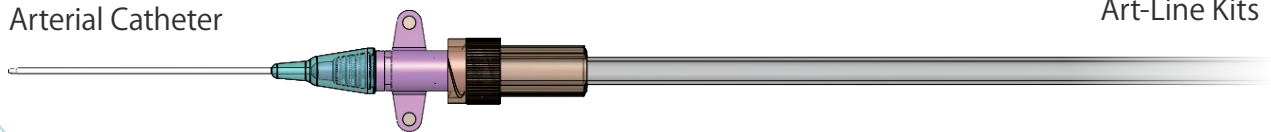

Biometrix's comprehensive product line for urine drainage management, includes high level urine meters, foley catheters with temperature sensor and intra-abdominal pressure sets with accurate pressure transducer monitoring.

Code	Description
UA-0000	500cc Urimetrix with 150cm Connecting Tube
UA-0001*	500cc Urimetrix, with Top Sampling Port and 150cm Connecting Tube
UA-0003	2000cc Urimetrix Exchange Bag with Emptying Tap
UA-0100*	500cc Urimetrix with 150cm Connecting Tube and Rigid Hook
UA-X0000	500cc Urimetrix with 115cm Connecting Tube
UA-X0010*	500cc Urimetrix with 115cm Connecting Tube and Top Sampling Port
UA-X0100*	500cc Urimetrix with 115cm Connecting Tube and Rigid Hook

Qty/Box: 10 UA-0003 Qty/Box: 50

All products have needle-free sampling ports



* Rigid Hook
UA-0100, UA-X0100

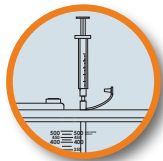

* Top Sampling Port
UA-0001, UA-X0010

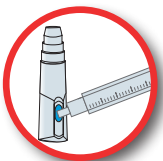

Needle-free Sampling Port



Foley Catheter with Temperature Sensor

Code	Description	Qty/Box
MN-0108	8Fr	25
MN-0110	10Fr	25
MN-0112	12Fr	25
MN-0114	14Fr	20
MN-0116	16Fr	20
MN-0118	18Fr	20

- Dual-purpose design can be used before, during, or after surgery
- Color-coded hubs for precise size identification
- Positive-locking connector for secure cable attachment
- 100% silicone

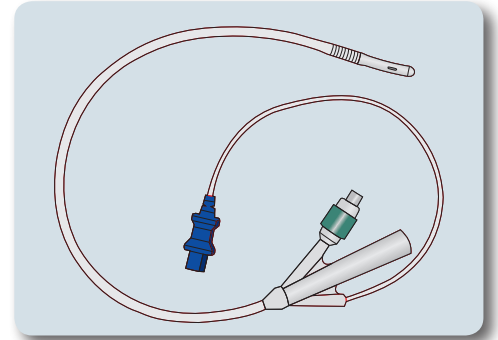

Adapting Cables for Foley Catheters

Code	Description	Qty/Box	Pin Configuration
ZF-0300	Monitors (except HP) requiring YSI 400 Series type thermistor sensor using female pins	1	
ZF-0301	All HP monitors YSI 400 Series	1	
ZF-0302	Siemens	1	

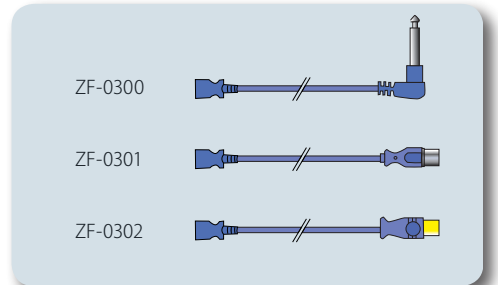

Intra-Abdominal Pressure (IAP) Monitoring Set

Code	Description
AP-1013*	Intra-Abdominal Pressure Monitoring Set with Disposable Transducer
CA-0200	Intra-Abdominal Pressure Monitoring Set

Qty/Box: 20

Set Contents

- I.V. Set
- Double Check-Valve
- 50ml Syringe
- 3 Way Stopcock
- Large Bore 3 Way Stopcock
- Stepped Adaptor
- Funnel Connector

(*) AP-1013 contains a Disposable Transducer

- Non-invasive and simple way to monitor IAP
- Connected between foley catheter and urine meter

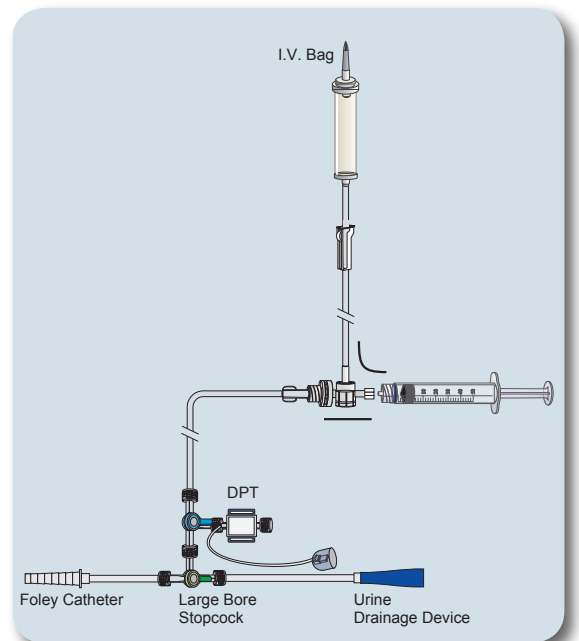

Manifolds, Stopcocks, IV Lines (DEHP Free)

Manifolds and Stopcocks

Code	Description	Qty/Box
CR-4010	4 Way Stopcock with 10cm Extension Line	100
CR-4025	4 Way Stopcock with 25cm Extension Line	100
BC-3003	3 Port Manifold Polysulphone F/F	50
BC-3005	5 Port Manifold Polysulphone F/F	50
BC-3013	3 Port Manifold Polysulphone M/F	50
BC-3015	5 Port Manifold Polysulphone M/F	50

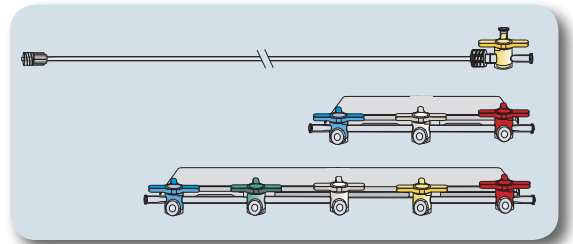

Mini-Bore Multi Infusion and Connecting Lines

Code	Description	Qty/Box
CN-2015	15cm F/M LL	100
CN-2030	30cm F/M LL	100
CN-2050	50cm F/M LL	100
CN-2150	150cm F/M LL	100
CN-4200	200cm M/M LL	150



Code	Description	Qty/Box
CN-5002	15cm 2 Way F/M LL	150
CN-5003	15cm 3 Way F/M LL	
CN-7010	10cm T-Type L	
CN-8010	10cm T-Type LL	

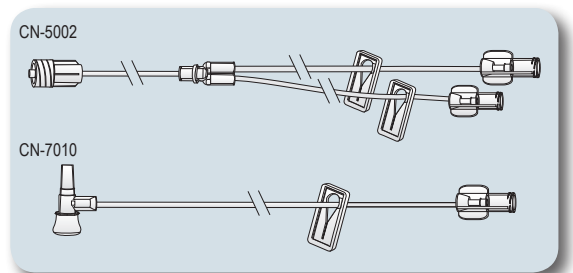

- Tubing: 1 x 2mm
- Priming Volume: 0.08ml/10cm

IV Line for Chemotherapy

Code	Description	Flow Regulator
CE-0201	0.2mic.	-
CE-0211	0.2mic.	+

Qty/Box: 25

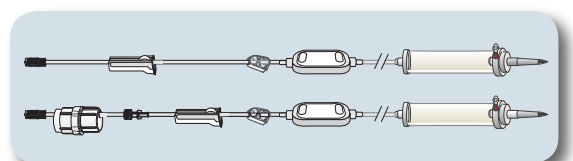

- Tubing: 2.6 x 4.1mm
- Priming Volume: 0.53ml/10cm

INFU-LINE™

Pediatric Neonate Biometrix's pediatric/neonatal intensive care solutions include single-use sterile medical devices for ensuring continuous, safe and appropriate treatment to newborns.

Nutrition Filter Sets

Filter Sets Pediatric

Code	Description
CD-0500	0.2 mic. Neonate Filter Set
CD-1500	1.2 mic. Neonate Filter Set

Qty/Box: 50

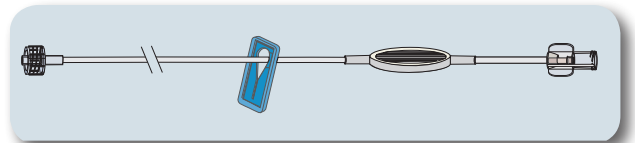

Filter Sets Amber Colored Pediatric

Code	Description
CD-X3010	Microspace Nutrition Set with 0.2, 1.2 mic. Filter, Clave, PVC DEHP Free Photoprotective Tubing
CD-X3030	Microspace Nutrition Set with 0.2, 1.2 mic. Filter, Clave, and T Adaptor Ending, PVC DEHP Free Photoprotective Tubing

Qty/Box: 50

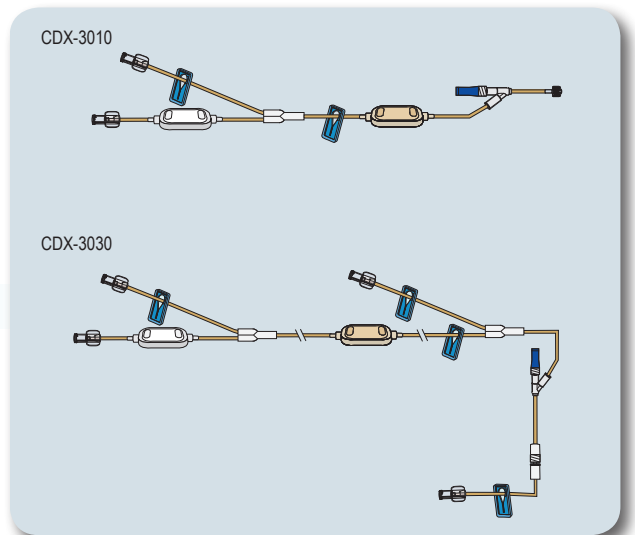

Customized sets available

Filter Sets Adult

Code	Description
CD-0400	0.2 mic. Filter Set
CD-1400	1.2 mic. Filter Set

Qty/Box: 50

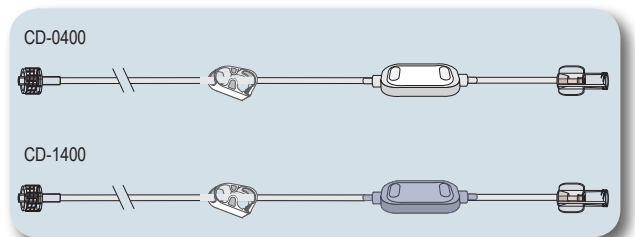

Filter Sets Amber Colored Adult

Code	Description
CD-2090	0.2 mic. Filter Set
CD-2190	1.2 mic. Filter Set

Qty/Box: 50

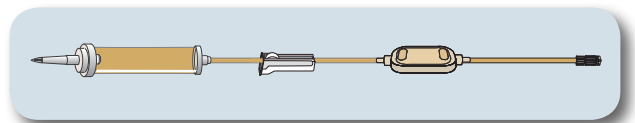

Customized sets available

IV Lines for Photosensitive Medication

Extension Lines Opaque

Code	Description
CL-1100	100cm Extension Line M/F
CL-1150	150cm Extension Line M/F

Qty/Box: 100

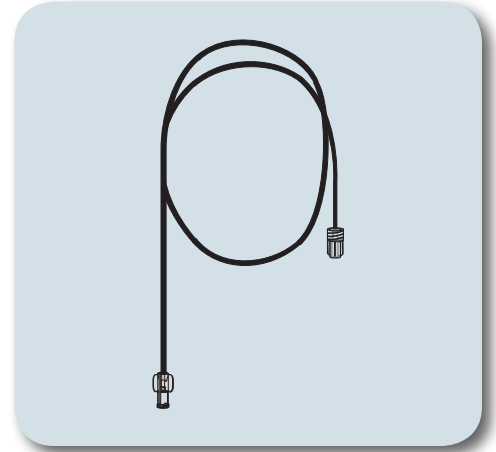

Extension Sets Amber Colored

Code	Description
CQ-0005	50ml Photoprotective Syringe
CQ-3200	100cm Photoprotective Extension Line F/MLL
CQ-3205	100cm Extension Line M/F with 50ml Photoprotective Syringe
CQ-3405	150cm Extension Line M/F with 50ml Photoprotective Syringe

Qty/Box: 25 CQ-3200: 50

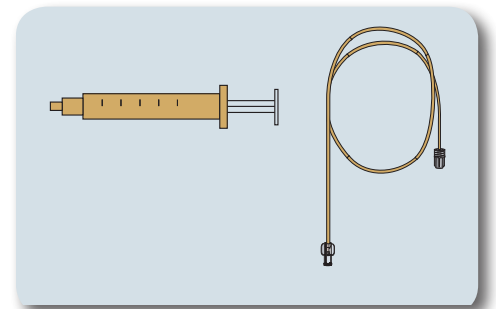

Microspace Extension Sets Amber Colored

Code	Description
CQ-1205	100cm Microspace Extension Line M/F with 50ml Photoprotective Syringe
CQ-1405	150cm Microspace Extension Line M/F with 50ml Photoprotective Syringe
CQ-2200	100cm Microspace Extension Line M/F
CQ-2400	150cm Microspace Extension Line M/F

Qty/Box: 25 CQ-2200: 100, CQ-2400: 50

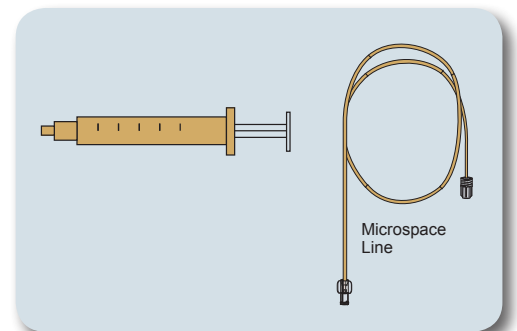

ANGIOGRAPHY & CATH-LAB

ANGIO-LINE™

HEMOSTATIC VALVE INTRODUCER SETS

MICROPUNCTURE HEMOSTATIC VALVE INTRODUCER SETS

MICROPUNCTURE SETS

MANIFOLD & CONTRAST MEDIA SETS

SYRINGES, STOPCOCKS & NEEDLES

POWER SYRINGES & PRESSURE LINES

COILED LINES & ANGIOGRAPHY WASTE BAG

PTCA KITS & ACCESSORIES

GUIDEWIRES

DRAPES & COVERS

CUSTOM PACKS

ANGIOGRAPHY

PIGTAIL DRAINAGE CATHETER SETS

BILIARY DRAINAGE CATHETER SET

DRAINAGE CATHETER INSERTION SET

ANGIO-LINE™

*Products and Accessories for Angiography with extensive experience and proven track record in angiography and cardiology, Biometrix offers a complete product line for interventional cardiology and radiology. Contrast media injection lines, sets and syringes, angiography guide wires, haemostatic valve introducer sets, PTCA accessories kits and comprehensive custom procedure trays – part of **BIOMETRIX CPT** program – are some of the **Angio-Line™** products and accessories*

Hemostatic Valve Introducer Sets

Short Length Pediatric Introducers

Code	Dilator Size	Needle	Packaging
HD-P6201	4Fr	+	Tray
HD-P6301	5Fr	+	Tray

Qty/Box: 10

Set Contents

- 7cm Sheath/Dilator Hemostatic Valve Unit with Side Arm and Stopcock
- 0.018" x 40cm Double Ended Guidewire
- 21Ga x 3.8cm Introducer Needle

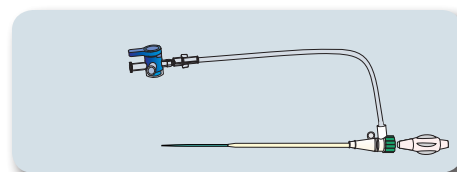

Standard Length Introducers

Code	Dilator Size	Needle	Packaging
HD-6301	5Fr	+	Tray
HD-6401	6Fr	+	Tray
HD-6501	7Fr	+	Tray
HD-6701	8Fr	+	Tray
HD-6801	9Fr	+	Tray
HD-7301	5Fr	-	Pouch
HD-7401	6Fr	-	Pouch
HD-7501	7Fr	-	Pouch
HD-7701	8Fr	-	Pouch
HD-7901	9Fr	-	Pouch
HD-X6301	5Fr	+	Pouch
HD-X6401	6Fr	+	Pouch
HD-X6501	7Fr	+	Pouch
HD-X6701	8Fr	+	Pouch
HD-X6801	9Fr	+	Pouch

Qty/Box: HD-XXXX: 10 / HD-XXXXX: 50

Set Contents

- 12cm Sheath/Dilator Hemostatic Valve Unit with Side Arm and Stopcock
- 0.038" x 50cm Double Ended Guidewire
- 18Ga x 7cm Introducer Needle

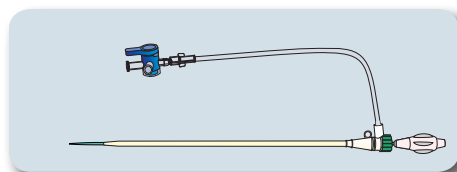

Long Length Introducers

Code	Dilator Size	Packaging
HD-9301	5Fr	Pouch
HD-9401	6Fr	Pouch
HD-9501	7Fr	Pouch
HD-9701	8Fr	Pouch

Qty/Box: 10

Set Contents

- 23cm Sheath/Dilator Hemostatic Valve Unit with Side Arm and Stopcock
- 0.038" x 70cm Double Ended Guidewire
- 18Ga x 7cm Introducer Needle

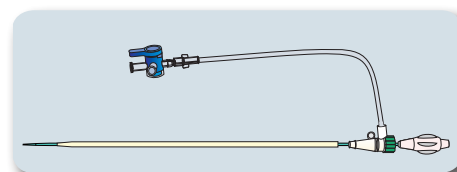

Micropuncture Hemostatic Valve Introducer Sets

Standard Length

Code	Dilator Size	Packaging
HD-Y6201	4Fr	Tray
HD-Y6301	5Fr	Tray
HD-Y6401	6Fr	Tray

Qty/Box: 10

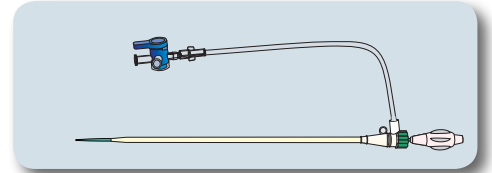

Set Contents

- 12cm Sheath/Dilator Hemostatic Valve Unit with Side Arm and Stopcock
- 0.018" x 40cm Stainless Steel Guidewire
- 21Ga x 3.8cm Introducer Needle
- 5ml Syringe

Long Length

Code	Dilator Size	Packaging
HD-X9301	5Fr	Pouch
HD-X9401	6Fr	Pouch
HD-X9501	7Fr	Pouch

Qty/Box: 10

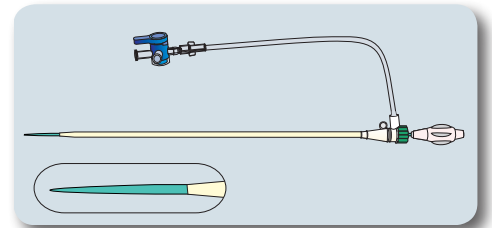

Set Contents

- 23cm Sheath/Dilator Hemostatic Valve Unit with Side Arm and Stopcock
- 0.018" x 70cm Stainless Steel Guidewire
- 21Ga x 3.8cm Introducer Needle

Split Sheath Introducer Sets

Code	Description
JF-0701	7Fr
JF-0801	8Fr
JF-0901	9Fr
JF-1001	10Fr
JF-1101	11Fr

Qty/Box: 10

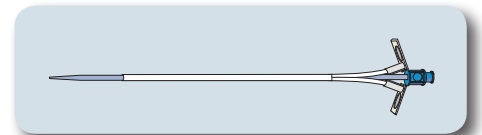

Set Contents

- Dilator Assembly
- 0.038" x 50cm Double Ended Guidewire
- 18Ga x 7cm Introducer Needle
- 5ml Syringe L/L

Micropuncture Sets

Micropuncture Sets

Code	Description	Guide Wire
HT-0210	4Fr Set	Nitinol
HT-0310	5Fr Set	Nitinol

Qty/Box: 10

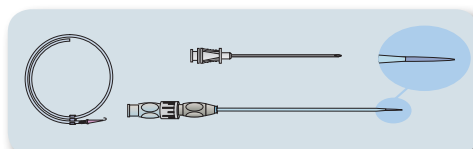

Set Contents

- 4Fr or 5Fr Vessel Dilator Set ● 0.018" x 40cm Guidewire ● 21 Ga x 7cm Introducer Needle

Advantages of Micropuncture

- Minimizes trauma and potential complications (hematoma)
- Minimizes venous spasm which can complicate or hinder the procedure
- Reduces post procedure mechanical phlebitis

Guidewires

Guidewire Code	Diameter	Length	Tip	J Radius	Features
HR-2242	0.018"	40cm	Platinum Floppy 3cm	3mm	Nitinol
HR-2542	0.018"	65cm	Platinum Floppy 3cm	3mm	Nitinol

Qty/Box: 50

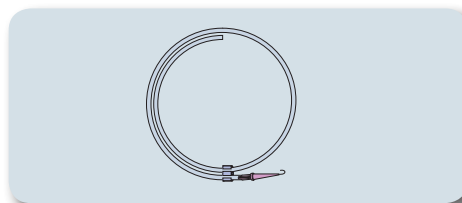

Introducer Needles

Code	Cannula Size	No. of parts	Bevel	Wing
HQ-1510	18Ga x 7cm	One Part	Standard	-
HQ-1511	18Ga x 7cm	One Part	Standard	+
HQ-1514	18Ga x 7cm	One Part	Short	-
HQ-1521	18Ga x 7cm	Two Part	Standard	-
HQ-1611	19Ga x 7cm	One Part	Standard	+
HQ-1525	18Ga x 9cm	One Part	Standard	+
HQ-1710	20Ga x 4cm	One Part	Standard	+
HQ-1810	21Ga x 3.8cm	One Part	Standard	-

Qty/Box: 100

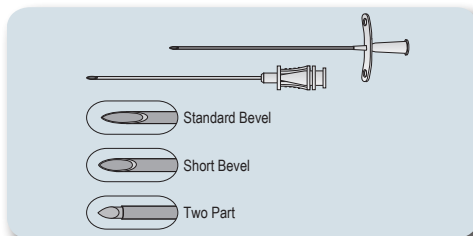

Manifold & Contrast Media Sets

Contrast Media Manifold Sets

Code	Description
BQ-1000	2 Port Angiography Manifold Set

Qty/Box: 25

Set Contents

- Infusion Set Vented
- Manifold 2 port F/F with 15cm High Pressure Line with rotating adaptor
- 12ml Finger Grip Syringe

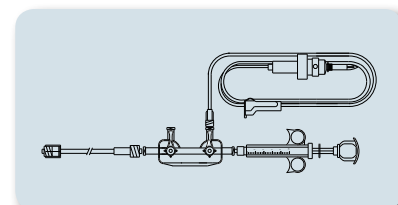

Code	Description
BQ-2000	Contrast Media Set

Qty/Box: 25

Set Contents

- Pressure Line • Double Check Valve • 3 Way High Pressure Stopcock
- Infusion Set Vented • 12ml Finger Grip Syringe

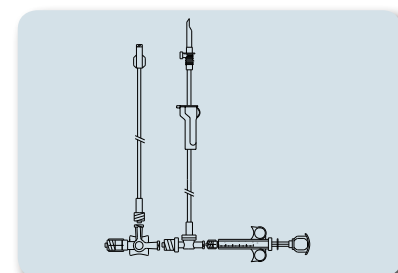

Code	Description
BQ-3000	3 Port Angiography Manifold Set

Qty/Box: 25

Set Contents

- Infusion Set • 3 Port Manifold F/Rot. MLL • 100cm Infusion Line F/MLL
- 12ml Finger Grip Syringe

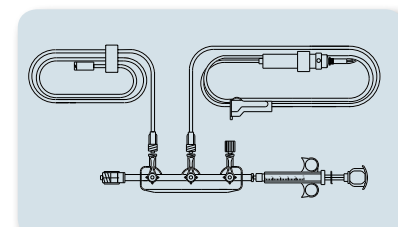

Syringes, Manifolds & Stopcocks

Finger Grip Syringe

Code	Description
BI-0121	12cc with Rotator

Qty/Box: 50

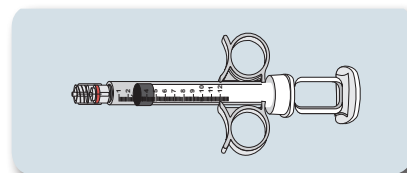

Angiography High Pressure Manifolds

Code	Ports & Position	Pressure Line
BE-2110	2 Right OFF	-
BE-2111	2 Right OFF	15cm High Pressure
BE-2120	2 Left OFF	-
BE-2210	2 Right ON	-
BE-3110	3 Right OFF	-
BE-3111	3 Right OFF	15cm High Pressure
BE-3120	3 Left OFF	-
BE-3210	3 Right ON	-

Qty/Box: 50

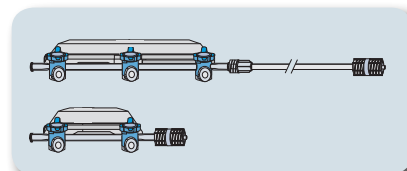

Angiography High Pressure Stopcocks

Code	Description
BE-1111	3 way High Pressure Stopcock with 10cm Pressure Line
BE-1148	2 way High Pressure Stopcock MLL
BE-1149	3 way High Pressure Stopcock with Rotating Adaptor MLL

Qty/Box: 50

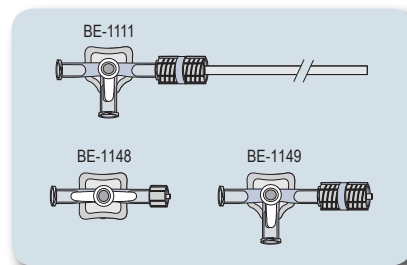

Power Syringes & Pressure Lines

Power Syringes

Code	Description	Qty/Box
BI-0538	150ml Injection Power Syringe with Filling Tube for Medrad Mark V and Mark V Plus Injectors	50
BI-0540	150ml Power Syringe for Angiomat 6000	60
BI-0548	200ml Injection Power Syringe with Filling Tube for Medrad Mark V and Mark V Plus Injectors	50
BI-0910	Filling Tube for Power Syringe	150

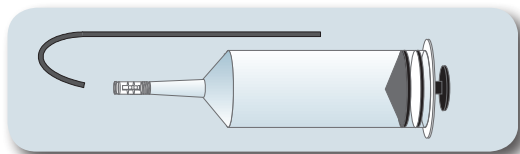

High Pressure Lines

Code	Length	PSI
BL-1075	75cm	800
BL-1125	125cm	800
BL-1160	160cm	800
BM-4025	25cm	1200
BM-4050	50cm	1200
BM-4075	75cm	1200
BM-4120	120cm	1200
BM-4160	160cm	1200
BM-4200	200cm	1200

Qty/Box: 50

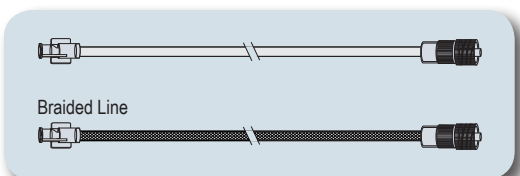

Braided high pressure line
Combines high pressure capacity with flexible tubing

Monitoring Lines

Code	Description	Qty/Box
AH-1015	15cm M/F	150
AH-1030	30cm M/F	150
AH-1050	50cm M/F	150
AH-1100	100cm M/F	150
AH-1150	150cm M/F	100
AH-1180	180cm M/F	100
AH-1200	200cm M/F	100
AH-2100	100cm M/M	150
AH-2150	150cm M/M	100
AH-2200	200cm M/M	100
AH-2240	240cm M/M	100

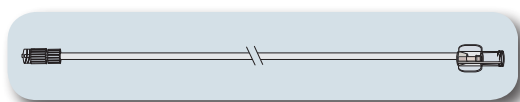

Pressure Line ID: 1.6mm, OD: 3.2mm
Material: PVC

Coiled Lines & Angiography Waste Bag

Coiled Low Pressure Sets

Code	Description
BQ-2010	Safety Filling Injecting Set
BQ-2118	CT/MRI Safety Filling Injecting Set
BO-1150	150cm Coiled Low Pressure Connecting Tube M/F
BO-5158	150cm Coiled Low Pressure T-Connected Tube with One Way Check Valve
BO-8150	150cm Coiled Low Pressure Connecting Tube with One Way Check Valve
BO-9150	150cm Coiled Low Pressure T-Connected Tube with Integrated Double Check Valve

Qty/Box: 25

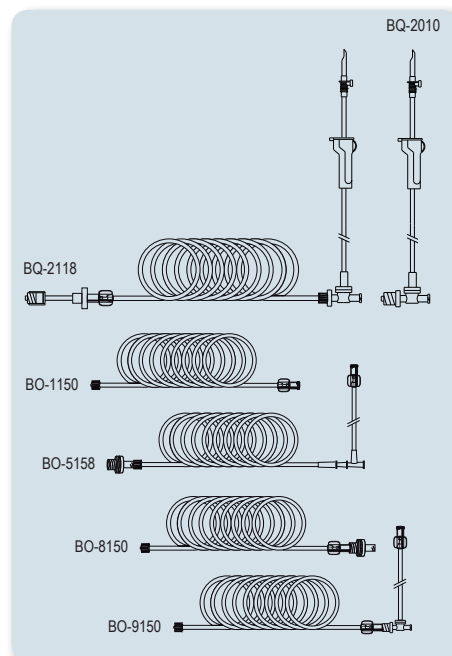

Angiography Waste Bag

The Angiography waste bag provides safe and efficient contrast media management.

Code	Description
BQ-0205	Double-Line Angiography Waste Bag
BQ-0215	Single-Line Angiography Waste Bag

Qty/Box: 25

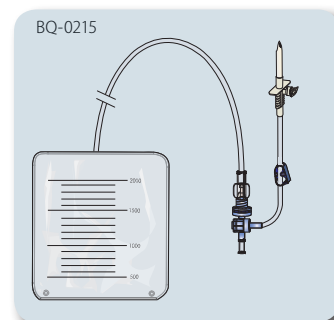
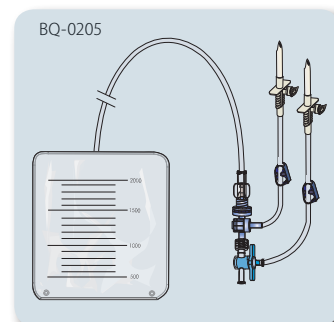

PTCA Kits & Accessories

Inflation Device

Code	Description	Qty/Box: 12
BQ-9001	Inflation Device 20cc	

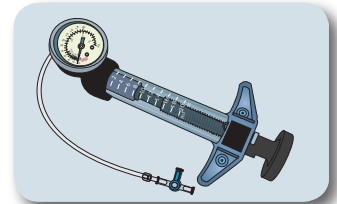

PTCA Kits

Code	Description	Qty/Box: 12
BQ-9050	PTCA Kit with Inflation Device	
BQ-9051	PTCA Kit with Inflation Device	
BQ-9060	PTCA Kit with Inflation Device	
BQ-9215	PTCA Kit with Inflation Device	
BQ-9216	PTCA Kit with Inflation Device	

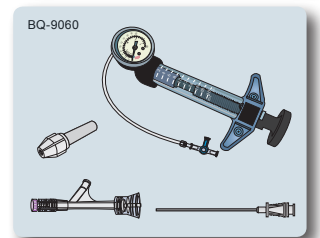
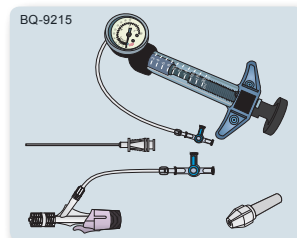
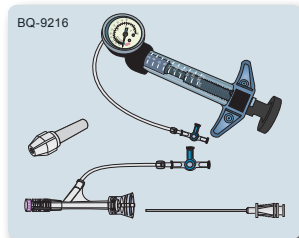
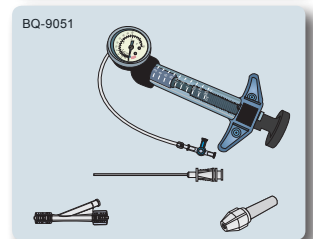
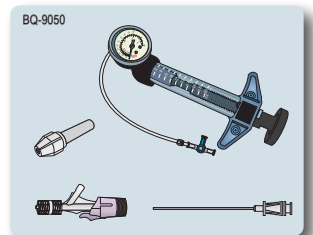

Angioplasty Valves and Accessories

Code	Description	Qty/Box
BQ-0504	Single Y-Angioplasty Valve	25
BQ-0505	Click Angioplasty Valve	20
BQ-0506	Push Pull Y Angiography Valve	25
BQ-0602	Single Y-Angioplasty Valve with Insertion Tool	25
BQ-0701	Double Y-Angioplasty Valve	25
BQ-0702	Double Y-Angioplasty Valve with Insertion Tool	25
BQ-0010	Torque Device for 0.014"-0.025" Guidewire	100
BQ-0015	Torque Device for 0.025"-0.040" Guidewire	50
BQ-0020	20Ga Metal Insertion Tool	100

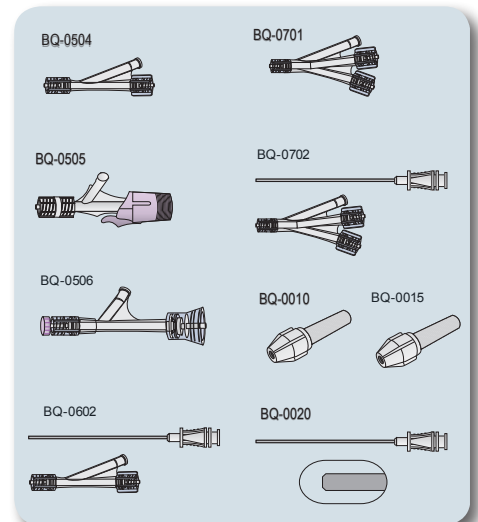

PTCA Kits & Accessories

Code	Set Contents	
BQ-0805	<ul style="list-style-type: none"> • Single Y-Angioplasty Valve • Torque Device • Insertion Tool 	
BQ-X0805	<ul style="list-style-type: none"> • Single Y-Angioplasty Valve with 20cm Side Arm and Stopcock • Torque Device • Insertion Tool 	
BQ-Y0805	<ul style="list-style-type: none"> • Double Y-Angioplasty Valve • Torque Device • Insertion Tool 	
BQ-0905	<ul style="list-style-type: none"> • Click Angioplasty Valve • Torque Device • Insertion Tool 	
BQ-0906	<ul style="list-style-type: none"> • Push Pull Y Angioplasty Valve • Torque Device • Insertion Tool 	
BQ-1905	<ul style="list-style-type: none"> • Click Angioplasty Valve with 20cm Side Arm and Stopcock • Torque Device • Insertion Tool 	
BQ-1906	<ul style="list-style-type: none"> • Push Pull Y Angioplasty Valve with 20cm Side Arm and Stopcock • Torque Device • Insertion Tool 	

Qty/Box: 25

Guide Wires

Angiography / Diagnostics

Used for a variety of angiography procedures.

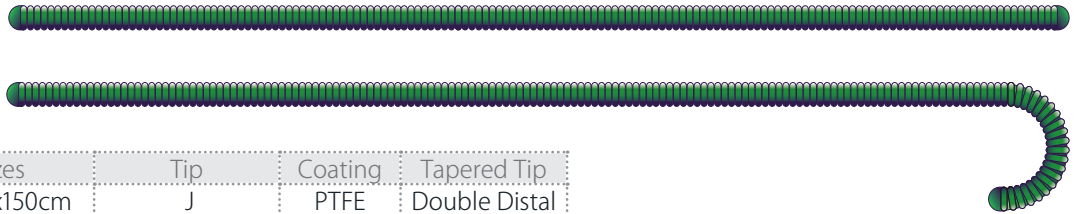

Code	Sizes	Tip	Coating	Tapered Tip
HR-3831	0.035"x150cm	J	PTFE	Double Distal
HR-5521	0.035"x150cm	J-Movable Core	PTFE	Single Distal
HR-3822	0.035"x150cm	J	PTFE	Single Distal
HR-3823	0.035"x150cm	J-Firm Body	PTFE	Single Distal
HR-3812	0.035"x150cm	Straight	PTFE	Single Distal
HR-3031	0.035"x180cm	J	PTFE	Double Distal
HR-3922	0.035"x260cm	J	PTFE	Single Distal
HR-3912	0.035"x260cm	Straight	PTFE	Single Distal
HR-4822	0.038"x150cm	J	PTFE	Single Distal
HR-4862	0.038"x150cm	Straight	PTFE	Single Distal
HR-4922	0.038"x260cm	J	PTFE	Single Distal
HR-4912	0.038"x260cm	Straight	PTFE	Single Distal

Qty/Box: 50

Hydrophilic

Hydrophilic Guide wires are designed to provide superior lubricity for enhanced control and steerability. Suited for a wide range of anatomical and clinical angiography applications.

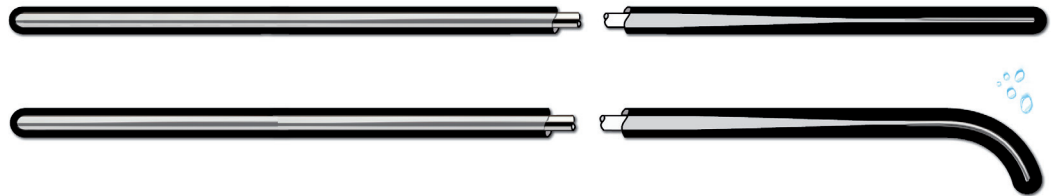

Code	Sizes	Stiffness	Tip
HR-2851	0.018"x150cm	Standard	Angled
HR-2051	0.018"x180cm	Standard	Angled
HR-3811	0.035"x150cm	Standard	Straight
HR-3818	0.035"x150cm	Stiff	Straight
HR-5654	0.035"x150cm	Standard	Angled
HR-5655	0.035"x150cm	Stiff	Angled
HR-6511	0.035"x180cm	Standard	Angled
HR-3631	0.035"x260cm	Stiff	Angled
HR-5641	0.035"x260cm	Standard	Angled
HR-4851	0.038"x150cm	Standard	Angled

Qty/Box: 5

Flexible Tip Length: 30mm

Guide Wires

Amplatz Super stiff

Used for catheter exchanges in various angiography procedures.

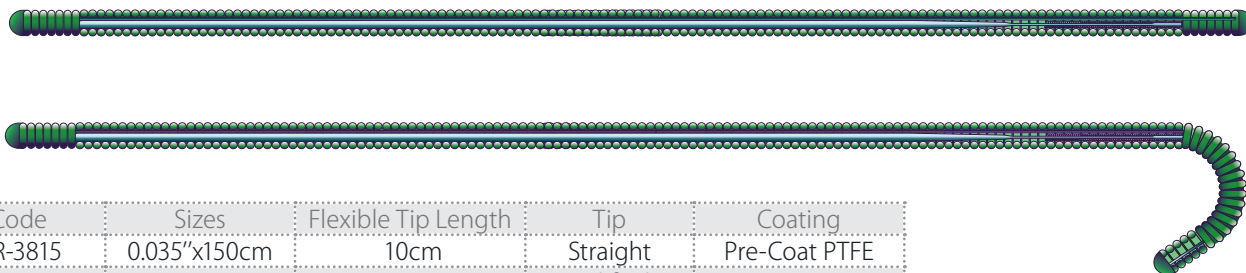

Code	Sizes	Flexible Tip Length	Tip	Coating
HR-3815	0.035"x150cm	10cm	Straight	Pre-Coat PTFE
HR-3825	0.035"x150cm	12cm	Modified J	Pre-Coat PTFE
HR-2922	0.035"x180cm	12cm	Modified J	Pre-Coat PTFE
HR-4821	0.038"x180cm	10cm	Straight	Pre-Coat PTFE
HR-3828	0.035"x260cm	12cm	Modified J	Pre-Coat PTFE
HR-4828	0.035"x260cm	10cm	Straight	Pre-Coat PTFE
HR-4815	0.038"x150cm	10cm	Straight	Pre-Coat PTFE

Qty/Box: 5

Bentson

Used for routine vascular and non-vascular angiography procedures.



Code	Sizes	Flexible Length	Tip	Coating
HR-7912	0.035"x150cm	Floppy	Straight	Pre-Coat PTFE

Qty/Box: 5

Rosen

Offers an intermediate level of body stiffness and the non-traumatic tip characteristics critical to the success in a wide variety of clinical vascular and non-vascular applications.

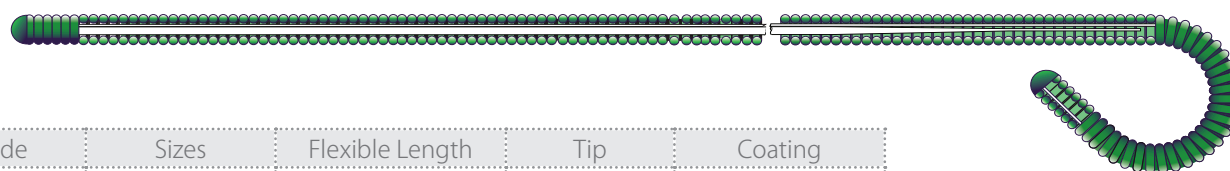

Code	Sizes	Flexible Length	Tip	Coating
HR-3827	0.035"x150cm	Heavy Duty	Tight J 1.5mm	Pre-Coat PTFE
HR-3929	0.035"x260cm	Heavy Duty	Tight J 1.5mm	Pre-Coat PTFE

Qty/Box: 5

Drapes & Covers

Surgical Gowns

Code	Specifications	Material	Size
DY-2001	Reinforced	SMS	M
DY-2002	Reinforced	SMS	L
DY-2003	Reinforced	SMS	XL
DY-2004	Standard	SMS	M
DY-2005	Standard	SMS	L
DY-2006	Standard	SMS	XL
DY-2012	Reinforced	Sontara	L
DY-2013	Reinforced	Sontara	XL



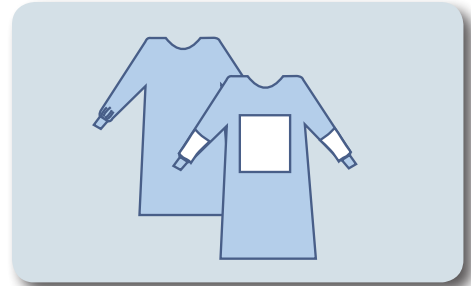

Qty/Box: 25



Reinforced Angiography Drape

Code	Description
BY-3001	220 X 300cm One Side Polyethylene Clear Film
BY-3002	240 x 300cm Two Sided Polyethylene Clear Film
BY-X3001	220 x 300cm One Side Polyethylene Clear Film (Full Absorbent)
BY-3015	280 x 300cm Radial Two Sided Polyethylene Clear Film

Qty/Box: 20

-  Polyethylene clear film
-  Reinforcement area
-  Fenestration area
-  Rectangle Adhesive area on fenestration area

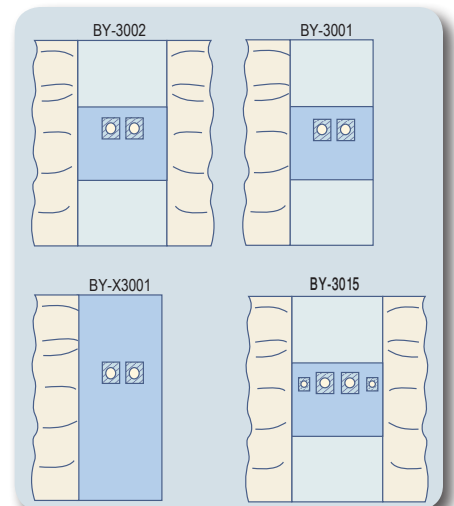

Catheterization Heart Pacemaker Drape

Code	Description
BY-3010	240 x 300cm Heart Pacemaker Drape
BY-3017	236 x 355cm Heart Pacemaker Drape

Qty/Box: 20

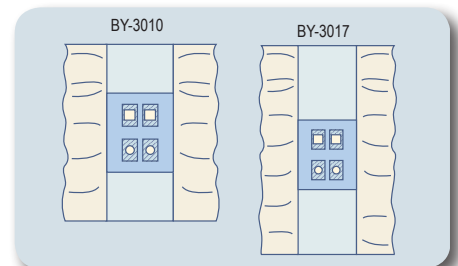

Equipment Covers

Code	Description
BY-1001	Image cover R-65 cm
BY-1002	Image cover R-35 cm
BY-1003	Image cover 100 x 100 cm
BY-2001	Protective cover 80 x 100 cm
BY-2002	Protective cover 100 x 100 cm
BY-2003	Protective cover 80 x 110 cm
BY-2004	Protective cover 120 x 120 cm
BY-2005	Keyboard cover 40 x 60 cm

Qty/Box: 50

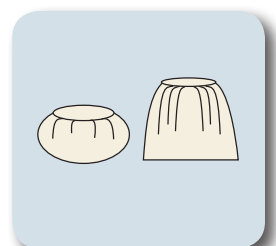

Material: Clear 50 micron PE

Custom Packs

Angiography Pack

Number	Bill of Materials	Qty.
1	3 Port Angio Manifold with Pressure Line and Rotator	1
2	Guidewire 0.035" x 150cm	1
3	Infuset Vented	1
4	Table Cover 137 x 150cm	1
5	Angio Drape 240 x 300cm with two sided PE clear film	1
6	Drape 50 x 60cm	3
7	Image Cover R-35	1
8	Protective Cover 80 x 110cm	1
9	12ml Finger Grip Syringe with Rotator	1
10	Introducer Needle 18Ga x 7cm	1

Qty/Box: 7

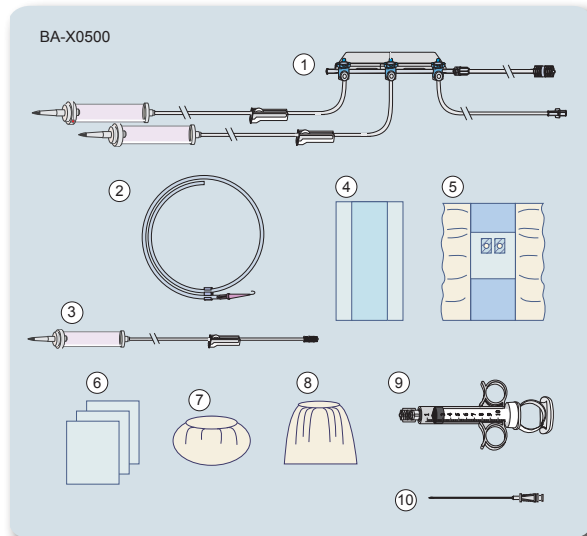

Heart Pacemaker Pack

Number	Bill of Materials	Qty.
1	Hypodermic Needle 21Ga	1
2	Hypodermic Needle 27Ga	1
3	10ml Syringe LL	1
4	Reinforced Gown XL	3
5	Heart Pacemaker Drape 236 x 355cm	1
6	Bowl 250ml	1
7	Bowl 500ml	2
8	Gauze 10 x 10cm	20
9	Cup 60ml	1
10	Image Cover R-65cm	1
11	Sponge Stick 8"	2
12	Table Cover 137 x 150cm	1
13	Tray 24 x 22 x 5cm	1
14	Needle Counter	1

Qty/Box: 8

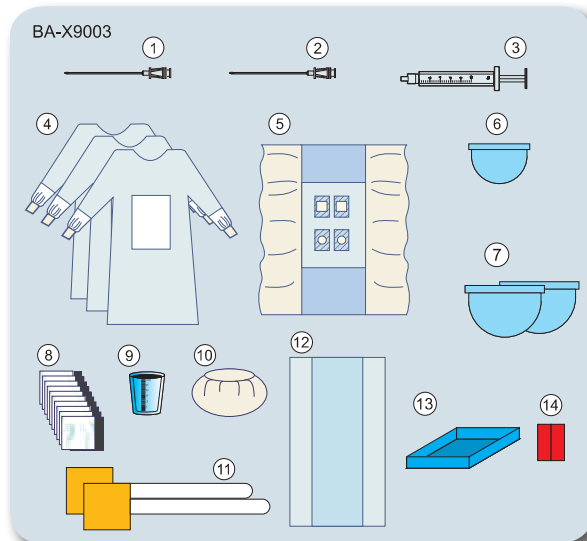

Customized sets available

Pigtail Catheter Sets

One Step Pigtail with Safety String Lock

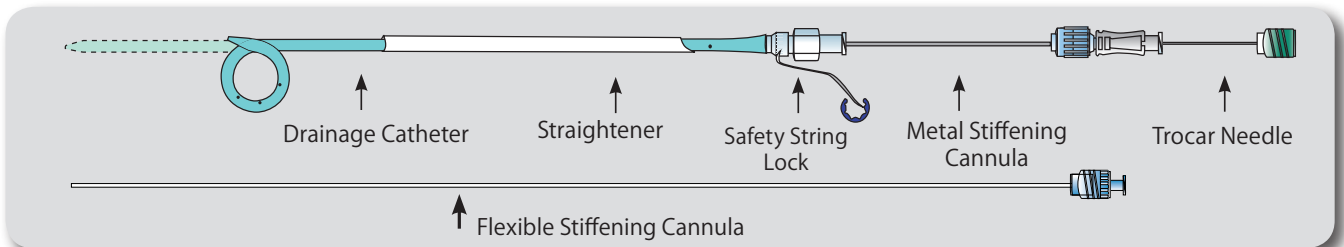

Code	French Size	Length	Accepts Guide Wire Diameter	Flexible Stiffening Cannula
NC-06191	6F	20cm	0.035"	-
NC-06241	6F	25cm	0.035"	-
NC-06291	6F	30cm	0.035"	-
NC-06391	6F	40cm	0.035"	-
NC-08191	8F	20cm	0.038"	-
NC-08241	8F	25cm	0.038"	-
NC-08291	8F	30cm	0.038"	-
NC-08391	8F	40cm	0.038"	-
NC-10191	10F	20cm	0.038"	-
NC-10241	10F	25cm	0.038"	-
NC-10291	10F	30cm	0.038"	-
NC-10391	10F	40cm	0.038"	-
NC-12191	12F	20cm	0.038"	-
NC-12241	12F	25cm	0.038"	-
NC-12291	12F	30cm	0.038"	-
NC-12391	12F	40cm	0.038"	-
NC-14191	14F	20cm	0.038"	-
NC-14241	14F	25cm	0.038"	-
NC-14291	14F	30cm	0.038"	-
NC-14391	14F	40cm	0.038"	-
NC-06192	6F	20cm	0.035"	+
NC-06242	6F	25cm	0.035"	+
NC-06292	6F	30cm	0.035"	+
NC-06392	6F	40cm	0.035"	+
NC-08192	8F	20cm	0.038"	+
NC-08242	8F	25cm	0.038"	+
NC-08292	8F	30cm	0.038"	+
NC-08392	8F	40cm	0.038"	+
NC-10192	10F	20cm	0.038"	+
NC-10242	10F	25cm	0.038"	+
NC-10292	10F	30cm	0.038"	+
NC-10392	10F	40cm	0.038"	+
NC-12192	12F	20cm	0.038"	+
NC-12242	12F	25cm	0.038"	+
NC-12292	12F	30cm	0.038"	+
NC-12392	12F	40cm	0.038"	+
NC-14192	14F	20cm	0.038"	+
NC-14242	14F	25cm	0.038"	+
NC-14292	14F	30cm	0.038"	+
NC-14392	14F	40cm	0.038"	+

Set Contents:

- Drainage Catheter
- Safety String Lock
- Metal Stiffening Cannula
- Trocar Needle
- Split Straightener

Customized sets available with the following optional contents:

- Connecting tube with 3 way stopcock
- Scalpel
- Drainage bag
- Securement

DRAINAGE CATHETER SETS

Pigtail Catheter Sets

One Step Pigtail with Safety String Lock for Ethanol Environment

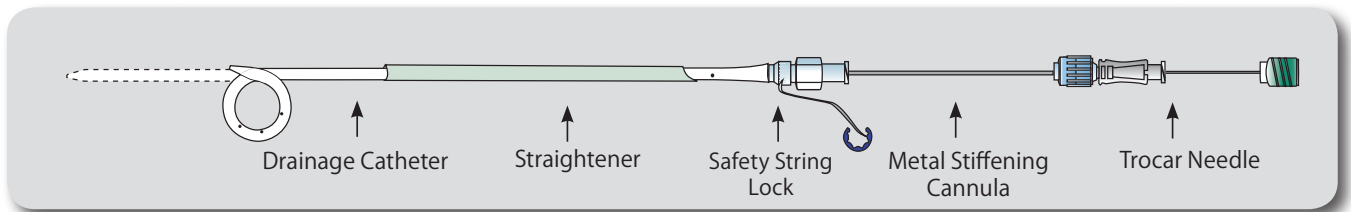

Code	French Size	Length	Accepts Guide Wire Diameter
NC-06193	6F	20cm	0.035"
NC-06243	6F	25cm	0.035"
NC-06293	6F	30cm	0.035"
NC-06393	6F	40cm	0.035"
NC-08193	8F	20cm	0.038"
NC-08243	8F	25cm	0.038"
NC-08293	8F	30cm	0.038"
NC-08393	8F	40cm	0.038"
NC-10193	10F	20cm	0.038"
NC-10243	10F	25cm	0.038"
NC-10293	10F	30cm	0.038"
NC-10393	10F	40cm	0.038"

Set Contents:

- Drainage Catheter for Ethanol Environment
- Safety String Lock
- Metal Stiffening Cannula
- Trocar Needle
- Split Straightener

Customized sets available with the following optional contents:

- Connecting tube with 3 way stopcock
- Scalpel
- Drainage bag
- Securement

Pigtail Catheter Sets

Closed Loop Pigtail with Safety String Lock (Seldinger Type)

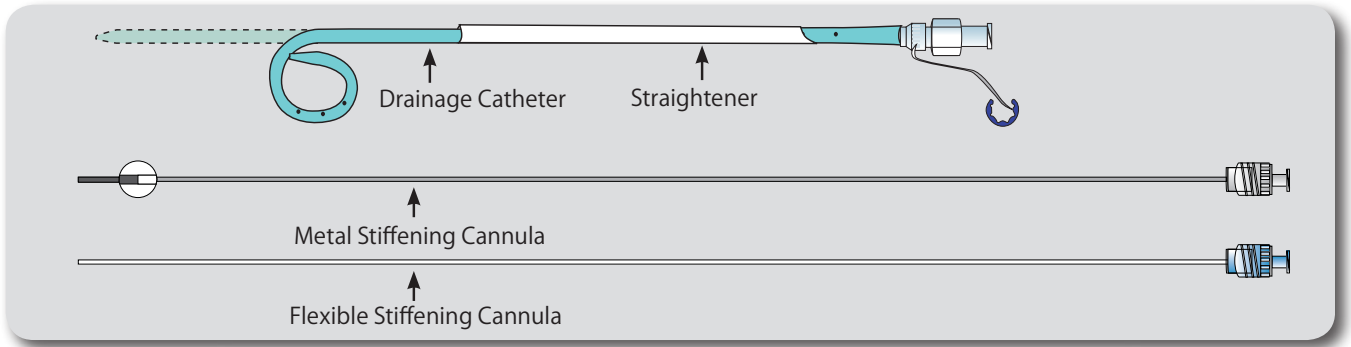

Code	French Size	Length	Accepts Guide Wire Diameter
NC-06194	6F	20cm	0.035"
NC-06244	6F	25cm	0.035"
NC-06294	6F	30cm	0.035"
NC-06344	6F	35cm	0.035"
NC-06394	6F	40cm	0.035"
NC-08194	8F	20cm	0.038"
NC-08244	8F	25cm	0.038"
NC-08294	8F	30cm	0.038"
NC-08344	8F	35cm	0.038"
NC-08394	8F	40cm	0.038"
NC-10194	10F	20cm	0.038"
NC-10244	10F	25cm	0.038"
NC-10294	10F	30cm	0.038"
NC-10344	10F	35cm	0.038"
NC-10394	10F	40cm	0.038"
NC-12194	12F	20cm	0.038"
NC-12244	12F	25cm	0.038"
NC-12294	12F	30cm	0.038"
NC-12344	12F	35cm	0.038"
NC-12394	12F	40cm	0.038"
NC-14194	14F	20cm	0.038"
NC-14244	14F	25cm	0.038"
NC-14294	14F	30cm	0.038"
NC-14344	14F	35cm	0.038"
NC-14394	14F	40cm	0.038"

Set Contents:

- Closed Loop Pigtail Drainage Catheter
- Safety String Lock
- Metal Stiffening Cannula
- Flexible Stiffening Cannula
- Split Straightener

Customized sets available with the following optional contents:

- Connecting tube with 3 way stopcock
- Scalpel
- Drainage bag
- Securement

DRAINAGE CATHETER SETS

Pigtail Catheter Sets

Closed Loop Pigtail (One Step Type)

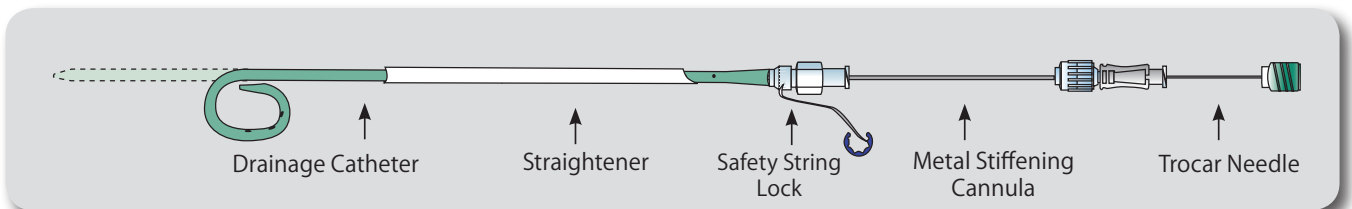

Code	French Size	Length	Accepts Guide Wire Diameter	Safety String Lock
NC-06195	6F	20cm	0.035"	+
NC-06245	6F	25cm	0.035"	+
NC-06295	6F	30cm	0.035"	+
NC-06395	6F	40cm	0.035"	+
NC-08195	8F	20cm	0.038"	+
NC-08245	8F	25cm	0.038"	+
NC-08295	8F	30cm	0.038"	+
NC-08395	8F	40cm	0.038"	+
NC-10195	10F	20cm	0.038"	+
NC-10245	10F	25cm	0.038"	+
NC-10295	10F	30cm	0.038"	+
NC-10395	10F	40cm	0.038"	+
NC-12195	12F	20cm	0.038"	+
NC-12245	12F	25cm	0.038"	+
NC-12295	12F	30cm	0.038"	+
NC-12395	12F	40cm	0.038"	+
NC-14195	14F	20cm	0.038"	+
NC-14245	14F	25cm	0.038"	+
NC-14295	14F	30cm	0.038"	+
NC-14395	14F	40cm	0.038"	+
NC-06196	6F	20cm	0.035"	-
NC-06246	6F	25cm	0.035"	-
NC-06296	6F	30cm	0.035"	-
NC-06396	6F	40cm	0.035"	-
NC-08196	8F	20cm	0.038"	-
NC-08246	8F	25cm	0.038"	-
NC-08296	8F	30cm	0.038"	-
NC-08396	8F	40cm	0.038"	-
NC-10196	10F	20cm	0.038"	-
NC-10246	10F	25cm	0.038"	-
NC-10296	10F	30cm	0.038"	-
NC-10396	10F	40cm	0.038"	-
NC-12196	12F	20cm	0.038"	-
NC-12246	12F	25cm	0.038"	-
NC-12296	12F	30cm	0.038"	-
NC-12396	12F	40cm	0.038"	-
NC-14196	14F	20cm	0.038"	-
NC-14246	14F	25cm	0.038"	-
NC-14296	14F	30cm	0.038"	-
NC-14396	14F	40cm	0.038"	-

Set Contents:

- Closed Loop Pigtail Drainage Catheter
- Metal Stiffening Cannula
- Trocar Needle
- Split Straightener

Customized sets available with the following optional contents:

- Connecting tube with 3 way stopcock
- Scalpel
- Drainage bag
- Securement

Biliary Catheter Sets

Biliary Catheter with Radiopaque Band and Safety String Lock

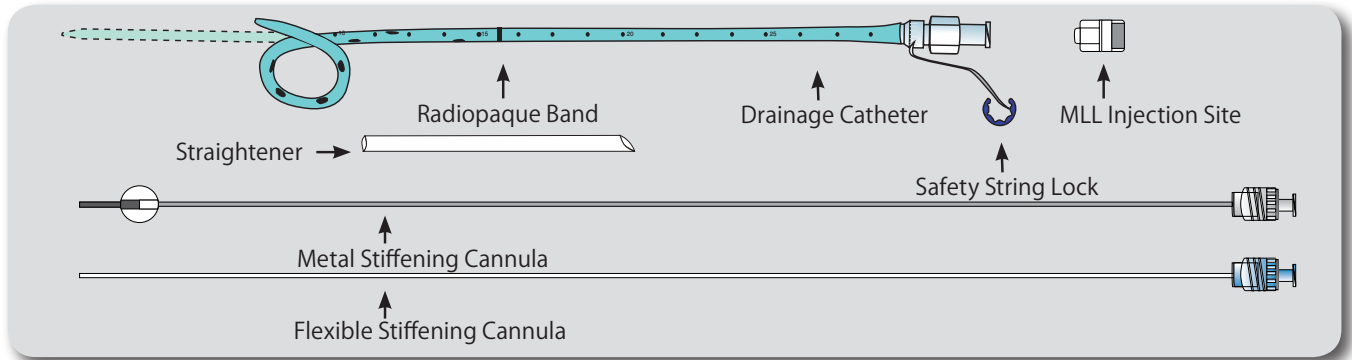

Code	French Size	Length	Accepts Guide Wire Diameter
NC-0619B	6F	20cm	0.035"
NC-0624B	6F	25cm	0.035"
NC-0629B	6F	30cm	0.035"
NC-0639B	6F	40cm	0.035"
NC-0644B	6F	45cm	0.035"
NC-0819B	8F	20cm	0.038"
NC-0824B	8F	25cm	0.038"
NC-0829B	8F	30cm	0.038"
NC-0839B	8F	40cm	0.038"
NC-0844B	8F	45cm	0.038"
NC-1019B	10F	20cm	0.038"
NC-1024B	10F	25cm	0.038"
NC-1029B	10F	30cm	0.038"
NC-1039B	10F	40cm	0.038"
NC-1044B	10F	45cm	0.038"
NC-1219B	12F	20cm	0.038"
NC-1224B	12F	25cm	0.038"
NC-1229B	12F	30cm	0.038"
NC-1239B	12F	40cm	0.038"
NC-1244B	12F	45cm	0.038"
NC-1419B	14F	20cm	0.038"
NC-1424B	14F	25cm	0.038"
NC-1429B	14F	30cm	0.038"
NC-1439B	14F	40cm	0.038"
NC-1444B	14F	45cm	0.038"

Set Contents:

- Biliary Drainage Catheter with Radiopaque Band
- Safety String Lock
- Metal Stiffening Cannula
- Flexible Stiffening Cannula
- Split Straightener
- MLL Injection Site

Customized sets available with the following optional contents:

- Connecting tube with 3 way stopcock
- Scalpel
- Drainage bag
- Securement

DRAINAGE CATHETER SETS Hydrophilic

Drainage Catheter Insertion Set

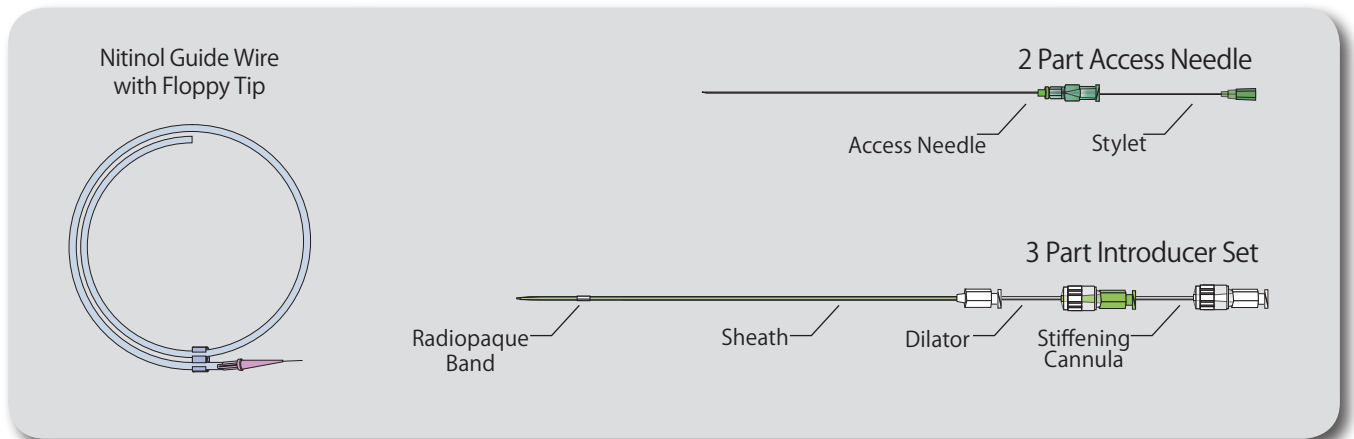

Code	Set Contents	Size
HD-N6410	Access Needle	21Gax15cm
	Stylet	OD: 0.5 mm
	Special Kink Resistant Guidewire	0.018"x 65cm
	Stiffening Cannula	22 Gauge
	Dilator	4Fr x 20cm
	Sheath with Hydrophilic Coating	6Fx18cm
	Radiopaque Band on Sheath	10mm from tip

Drainage Catheter Connectors

Code	Description	Stopcock	Qty/Box
DQ-0305	5cm	-	50
DQ-0325	25cm	-	50
DQ-0430	40cm	+	100

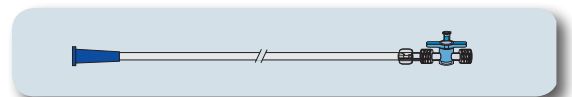

SURGERY



CHEST DRAINAGE SYSTEMS

Thorametrix™

Pneumothorax Sets

Trocar Catheters

Thoracic Catheters

WOUND DRAINAGE

Biovac™

Silicone Drains

Drains

Minivac, Drains and Accessories

Gravitational Drainage Sets and Accessories

CSF DRAINAGE AND ICP MONITORING SYSTEM

CHEST DRAINAGE SYSTEMS

Thorametrix™

The Thorametrix™ system is a post-operative chest drainage system that is used for draining air or liquids from the pleural cavity. It presents a simple and convenient drainage system for maintaining the required amount of vacuum in patients' chests while controlling the level of suction.

Code	Description
NC-5512	2300ml System, High Capacity

Qty/Box: 5

Set Contents

- 2300ml Chest Drainage System
- 2 Tubing Set with Anti-Kink
- Filling Funnel

High capacity double chest drainage is the answer for intensive care and cardio-thoracic units

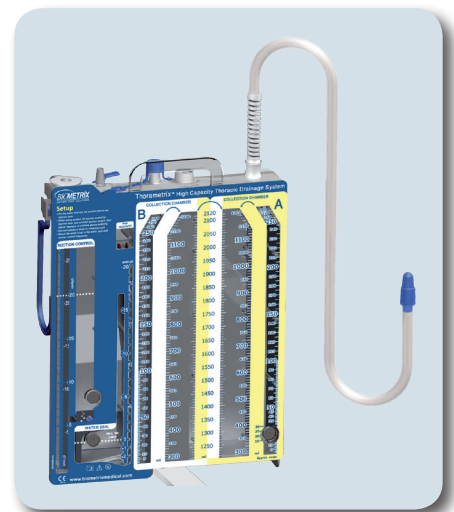

Code	Description
NC-3311	1150ml System, Compact

Qty/Box: 5

Set Contents

- 1150ml Chest Drainage System
- 1 Tubing Set with Anti-Kink
- Filling Funnel

Compact size is ideal for newborn and pediatric cases

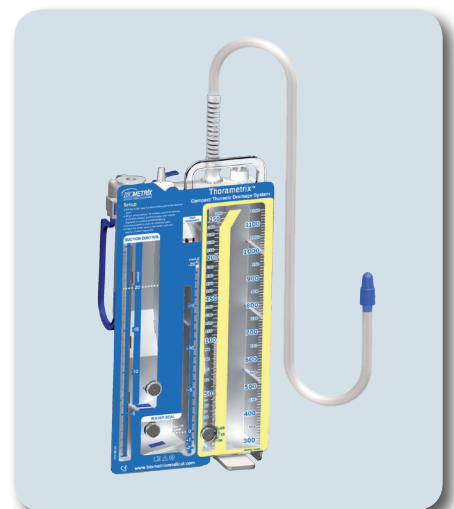

Thorametrix™

Dry Thoracic Drainage System

Biometrix's Dry Suction Control system, which provides dry suction control regulation, is based on the reliable and advanced technology of Thorametrix™ drainage systems.

Code	Description
NC-7512	2300ml System, High Capacity Dry

Qty/Box: 5

Set Contents

- 2300ml Chest Drainage System
- 2 Tubing Set with Anti-Kink
- Filling Funnel

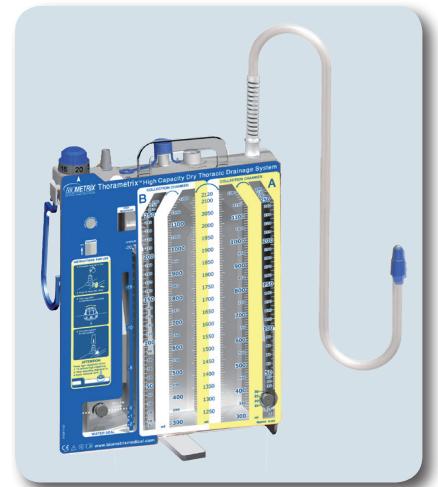

Code	Description
NC-8311	1150ml System, Compact Dry

Qty/Box: 5

Set Contents

- 1150ml Chest Drainage System
- 1 Tubing Set with Anti-Kink
- Filling Funnel



Compact size is ideal for newborn and pediatric cases

CHEST DRAINAGE SYSTEMS

Thorametrix™

Biometrix offers a product version with a quick disconnecting possibility on the tubing set. There is a slide clamp which enables safe disconnection of the system. This allows replacement of the system efficiently and easily.

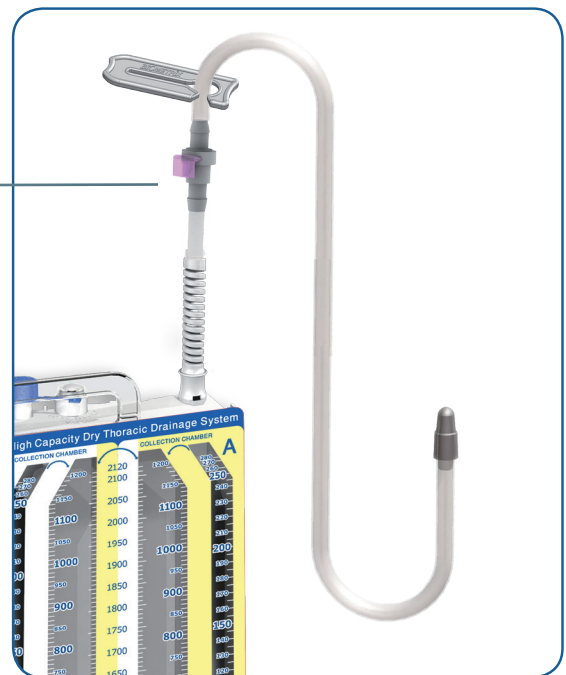
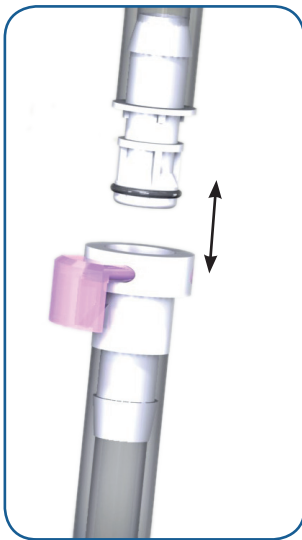

Code	Description	Qty/Box: 20
1CL005	Open Slide Clamp XL	

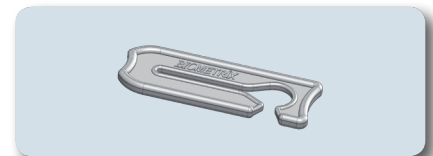

Single Bottle System

Draining air and/or liquids from the pleural cavity. Biometrix's single bottle system, part of the Thorametrix™ product line, is used for draining air and/or liquids from the pleural cavity.

Code	Description	Qty/Box: 20
NE-1101	Thorametrix Single Chest Drainage System	

Set Contents

- 1100ml Chest Drainage System
- 1 Tubing Set with Anti-Kink Springs

Automatic integral valve limits the vacuum to -40cmH²0



Pneumothorax Sets

Code	Description
NP-1000	Non Seldinger Type Pneumothorax Set

Qty/Box: 10

Set Contents

- Radiopaque Drainage Catheter with 6Fr Dilator Assembly Needle (20Ga)
- Connecting Tube with 3 Way Stopcock • Scalpel • 10ml Syringe • Stepped Adaptor

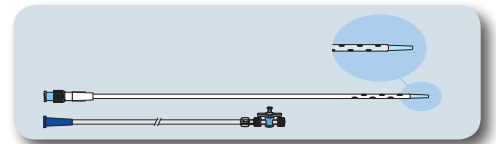

Code	Description
NP-1001	Seldinger Type Pneumothorax Set

Qty/Box: 10

Set Contents

- Radiopaque Drainage Catheter with 6Fr Dilator Assembly
- Connecting Tube with 3 Way Stopcock • 0.032" Stiff Guidewire J-Flex Tip
- 10ml Syringe • 18Ga x 7cm Introducer Needle • Scalpel #11 with Short Handle
- Stepped Adaptor • 800ml Drainage Bag • Drape 50x50cm • Heimlich Valve

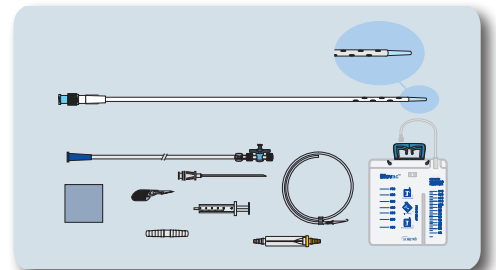

Code	Description
NP-1005	Seldinger Type Pneumothorax Set

Qty/Box: 10

Set Contents

- Radiopaque Drainage Catheter with 6Fr Dilator Assembly
- Connecting Tube with 3 Way Stopcock • 0.032" Stiff Guidewire J-Flex Tip
- 18Ga x 7cm Introducer Needle • Scalpel • 10ml Syringe • Stepped Adaptor

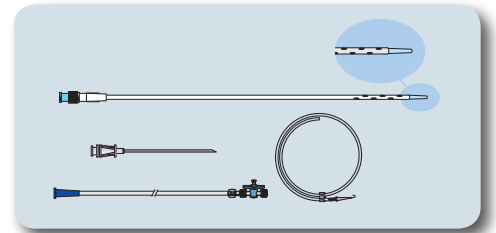

Code	Description
NP-2000	Pneumothorax Pigtail Catheter Set

Qty/Box: 10

Set Contents

- 14Fr X 29cm Pneumothorax Catheter • Metal Stiffening Cannula
- Metal Trocar Needle • Connecting Tube with 3 way stopcock • Scalpel

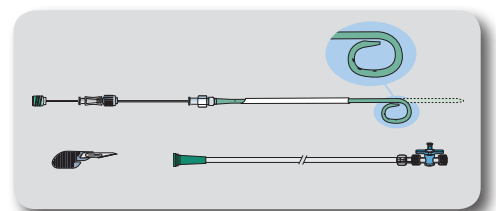

CHEST DRAINAGE

Thoracic Catheters, Trocar Catheters

PVC Radiopaque Thoracic Catheters

Code	Description	Fr. Size
NM-1160	Straight	16
NM-1200	Straight	20
NM-1240	Straight	24
NM-1280	Straight	28
NM-1320	Straight	32
NM-1360	Straight	36
NM-2160	Right Angle	16
NM-2200	Right Angle	20
NM-2240	Right Angle	24
NM-2280	Right Angle	28
NM-2320	Right Angle	32
NM-2360	Right Angle	36

Qty/Box: 50

Description

- 50cm Length ● Radiopaque stripe
- Stepped Adaptor included in all catheters

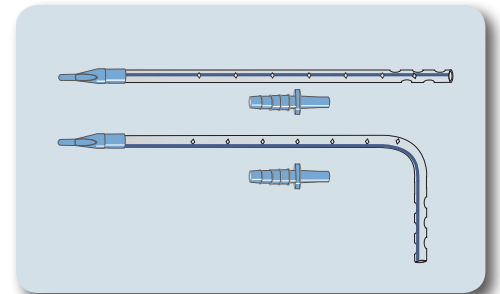

Silicone Radiopaque Thoracic Catheters

Code	Fr. Size
NL-1620	16
NL-1820	18
NL-2020	20
NL-2420	24
NL-2820	28
NL-3220	32
NL-3620	36

Qty/Box: 50

Description

- 70cm Length ● Radiopaque stripe ● Stepped Adaptor included in all catheters

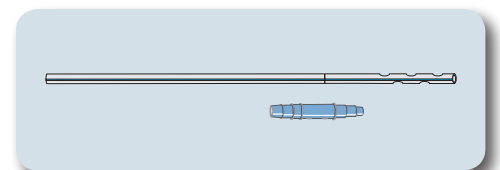

Trocar Catheters

Code	Fr. Size	Length
NN-0008	8	20cm
NN-0010	10	23cm
NN-0012	12	23cm
NN-0016	16	23cm
NN-0020	20	39cm
NN-0024	24	39cm
NN-0028	28	39cm
NN-0032	32	39cm

Qty/Box: 20

Description

- Biocompatible PVC ● Radiopaque stripe ● Depth marks ● 3cm perforation

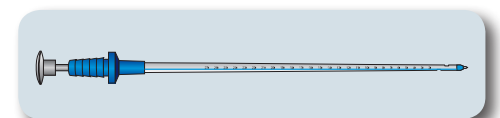

Biovac™

Biometrix offers evacuators and drains designed to enhance drainage performance and facilitate wound healing and infection reduction.

Biometrix's complete closed wound drainage systems consist of closed, flat, and fluted drain systems, suitable for the various types of surgical procedures.

450ml Spring Type Evacuator Systems

Sets without Drains

Code	Bag
MJ-0000	+
ML-0000	-

Qty/Box: 20

Sets with Round PVC Drains

Code	Bag	Drain	Trocar
MJ-5105	+	10Fr	+
ML-5105	-	10Fr	+
MJ-5125	+	12Fr	+
ML-5125	-	12Fr	+
MJ-5145	+	14Fr	+
ML-5145	-	14Fr	+
MJ-5165	+	16Fr	+
ML-5165	-	16Fr	+
MJ-5185	+	18Fr	+
ML-5185	-	18Fr	+

Qty/Box: 20

Sets with Round Silicone Drains

Code	Bag	Drain	Trocar
MJ-2105	+	10Fr	+
ML-2105	-	10Fr	+
MJ-2125	+	12Fr	+
ML-2125	-	12Fr	+
MJ-2145	+	14Fr	+
ML-2145	-	14Fr	+
MJ-2165	+	16Fr	+
ML-2165	-	16Fr	+
MJ-2185	+	18Fr	+
ML-2185	-	18Fr	+

Qty/Box: 20

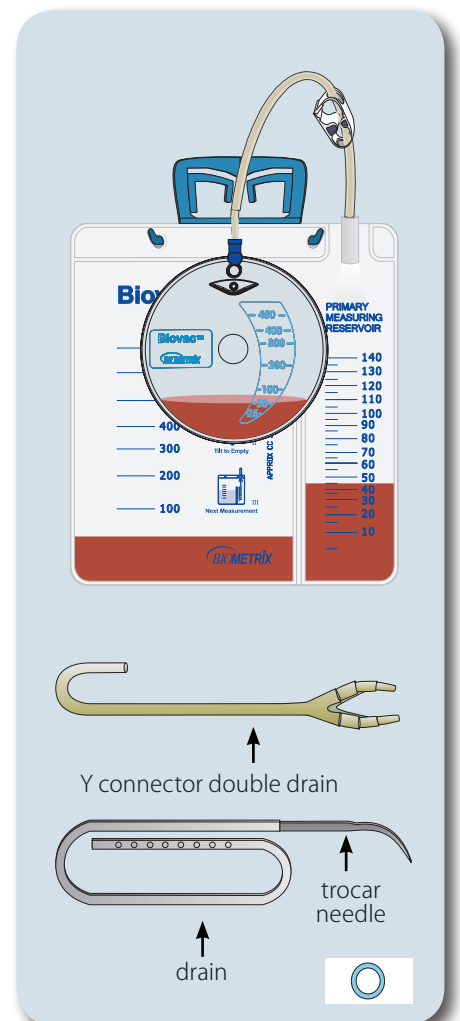

All sets contain a Y connector double drain and drains with trocar needle

WOUND DRAINAGE

Biovac™

450ml Spring Type Evacuator Systems

Sets with Flat Silicone Drains



Code	Bag	Drain	Trocar
MJ-1075	+	7mm	+
ML-1075	-	7mm	+
MJ-1105	+	10mm	+
ML-1105	-	10mm	+

Qty/Box: 20

All sets contain a Y connector double drain and drains with trocar needle

Sets with Flat Fluted Silicone Drains



Code	Bag	Drain	Trocar
MI-1075	-	7mm	+
MM-1075	+	7mm	+
MI-1105	-	10mm	+
MM-1105	+	10mm	+

Qty/Box: 20

Sets with Round Fluted Silicone Drains



Code	Bag	Drain	Trocar
MI-3105	-	10Fr	+
MM-3105	+	10Fr	+
MI-1155	-	15Fr	+
MM-1155	+	15Fr	+
MI-1195	-	19Fr	+
MM-1195	+	19Fr	+

Qty/Box: 20

All sets contain drains with trocar needle

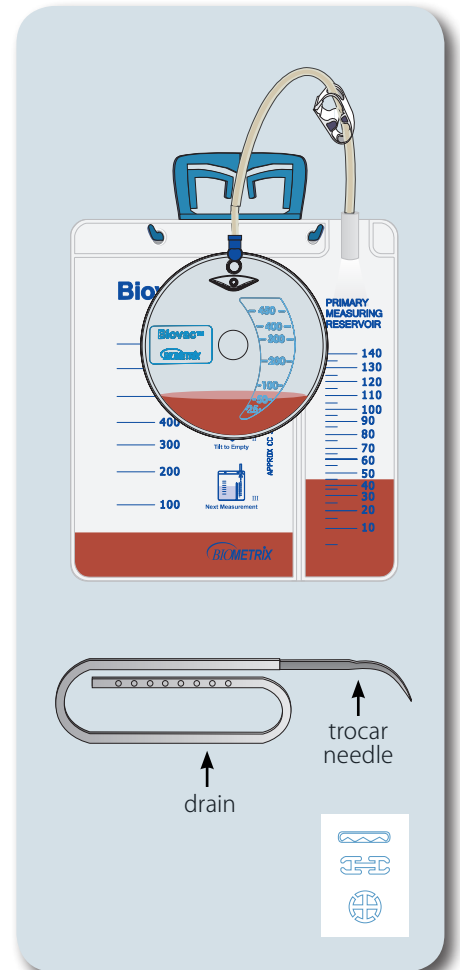

Biovac™

100ml Bulb Systems

Sets without Drains

Code	Bag	Qty/Box
MD-0000	+	25
MF-0000	-	20

Sets with Round Silicone Drains



Code	Bag	Drain	Trocar	Qty/Box
MD-2100	+	10Fr	-	25
MF-2100	-	10Fr	-	20
MD-2105	+	10Fr	+	25
MF-2105	-	10Fr	+	20
MD-2120	+	12Fr	-	25
MF-2120	-	12Fr	-	20
MD-2125	+	12Fr	+	25
MF-2125	-	12Fr	+	20
MD-2140	+	14Fr	-	25
MF-2140	-	14Fr	-	20
MD-2145	+	14Fr	+	25
MF-2145	-	14Fr	+	20
MD-2160	+	16Fr	-	25
MF-2160	-	16Fr	-	20
MD-2165	+	16Fr	+	25
MF-2165	-	16Fr	+	20
MD-2180	+	18Fr	-	25
MF-2180	-	18Fr	-	20
MD-2185	+	18Fr	+	25
MF-2185	-	18Fr	+	20

Sets with Flat Silicone Drains



Code	Bag	Drain	Trocar	Qty/Box
MD-1040	+	4mm	-	25
MF-1040	-	4mm	-	20
MD-1045	+	4mm	+	25
MF-1045	-	4mm	+	20
MD-1070	+	7mm	-	25
MF-1070	-	7mm	-	20
MD-1075	+	7mm	+	25
MF-1075	-	7mm	+	20
MD-1100	+	10mm	-	25
MF-1100	-	10mm	-	20
MD-1105	+	10mm	+	25
MF-1105	-	10mm	+	20

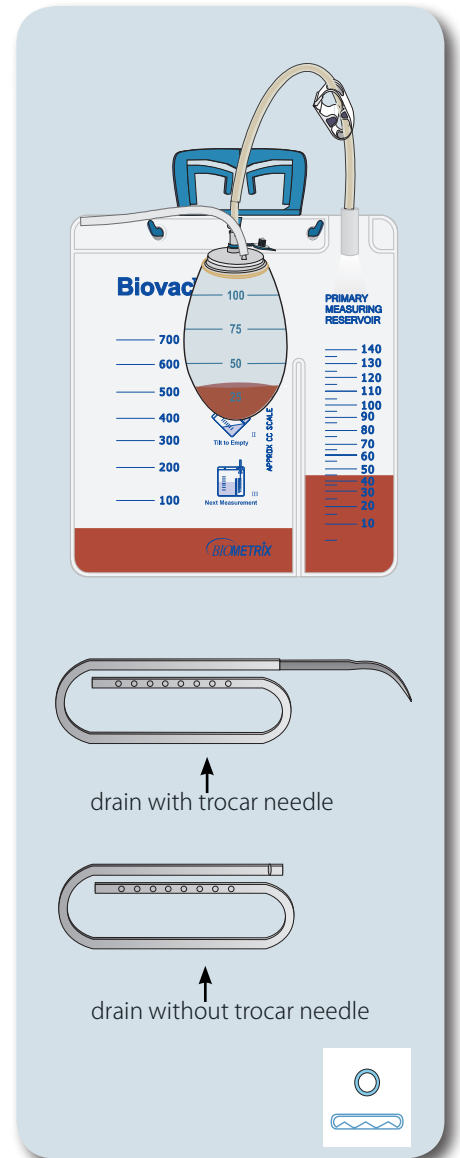

WOUND DRAINAGE

Biovac™

100ml Bulb Systems

Sets with Round Fluted Drains



Code	Bag	Drain	Trocar
MA-3105	-	10Fr	+
MK-3105	+	10Fr	+
MA-1155	-	15Fr	+
MK-1155	+	15Fr	+
MA-1195	-	19Fr	+
MK-1195	+	19Fr	+

Qty/Box: MA-XXXX: 20, MK-XXXX:25

Sets with Flat Fluted Drains



Code	Bag	Drain	Trocar
MA-1075	-	7mm	+
MK-1075	+	7mm	+
MA-1105	-	10mm	+
MK-1105	+	10mm	+

Qty/Box: MA-XXXX: 20, MK-XXXX:25

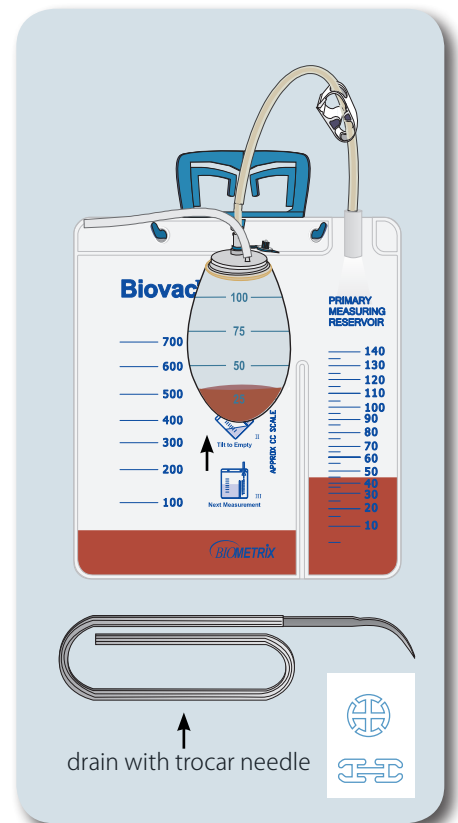

400ml Pre-Vacuum Systems

Code	Bag
MQ-0000	Biovac Pre-Vacuum with Extension Line and Stopcock MLL
MQ-0001	Biovac Pre-Vacuum with Double Drain Connector Extension Line
MQX-0002	Biovac Pre-Vacuum with 85cm Extension Line

Qty/Box: 25



Silicone Drains

Fluted Drain and Bendable Trocar



Code	Description	Drain	Trocar Needle
MW-J1075	Flat	7Fr	+
MW-J1105	Flat	10Fr	+
MW-J3105	Round	10Fr	+
MW-J3155	Round	15Fr	+
MW-J3195	Round	19Fr	+

Qty/Box: 20

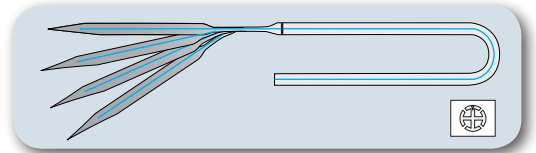

Fluted Round Drain



Code	Description	Drain	Trocar Needle
MW-3100	Round	10Fr	-
MW-3105	Round	10Fr	+
MW-3150	Round	15Fr	-
MW-3155	Round	15Fr	+
MW-3190	Round	19Fr	-
MW-3195	Round	19Fr	+
MW-3240	Round	24Fr	-

Qty/Box: MW-XXX0: 25, MW-XXX5:20

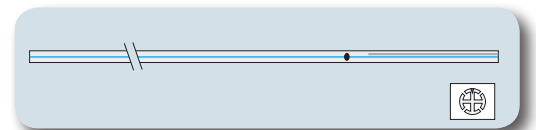

Radiopaque Stripe

Fluted Flat Drain



Code	Description	Drain	Trocar Needle
MW-1070	Flat	7mm	-
MW-1075	Flat	7mm	+
MW-1100	Flat	10mm	-
MW-1105	Flat	10mm	+

Qty/Box: MW-XXX0: 25, MW-XXX5:20

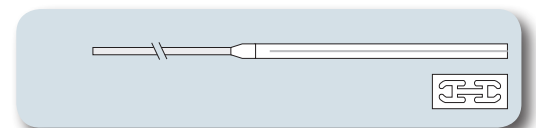

Full Radiopaque

Flat Silicone Drains



Code	Drain	Trocar Needle
MV-1040	4mm	-
MV-1070	7mm	-
MV-1075	7mm	+
MV-1100	10mm	-
MV-1105	10mm	+

Qty/Box: 50

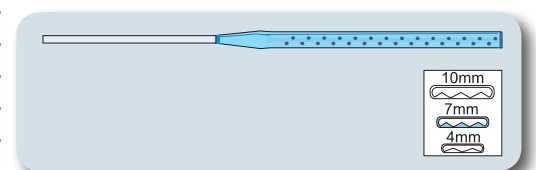

Radiopaque Stripe

WOUND DRAINAGE

Drains

Round PVC Drains

Code	Drain	Trocar
MV-5085	8Fr	-
MV-5105	10Fr	-
MV-5125	12Fr	-
MV-5145	14Fr	-
MV-5165	16Fr	-
MV-5185	18Fr	-
MV-8085	8Fr	+
MV-8105	10Fr	+
MV-8125	12Fr	+
MV-8145	14Fr	+
MV-8165	16Fr	+
MV-8185	18Fr	+

Qty/Box: 50 MV-5085, MV-5185: 100

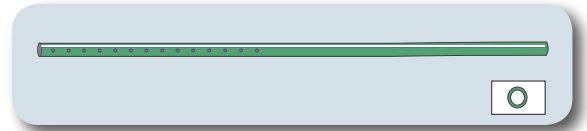

Radiopaque Stripe

Round Silicone Drains

Code	Fr. Size	Length	Trocar
MV-2105	10Fr	60cm	-
MV-2125	12Fr	60cm	-
MV-2128	12Fr	120cm	-
MV-2145	14Fr	60cm	-
MV-2148	14Fr	120cm	-
MV-2165	16Fr	60cm	-
MV-2168	16Fr	120cm	-
MV-2185	19Fr	60cm	-
MV-2198	19Fr	120cm	-
MV-9205	10Fr	60cm	+
MV-9245	14Fr	60cm	+
MV-9285	18Fr	60cm	+
MV-9405	10Fr	125cm	+
MV-9445	14Fr	125cm	+
MV-9485	18Fr	125cm	+

Qty/Box: 50 MV-2198: 100

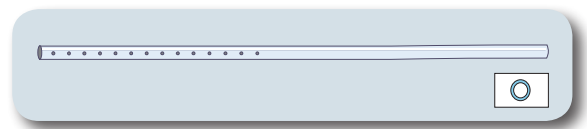

Radiopaque Stripe

Minivac, Drains and Accessories

50ml Minivac Systems

Code	Drain	L1	L2	Needle
MH-1170	6Fr PVC - Round	50cm	14cm	-
MH-1175	6Fr PVC - Round	50cm	14cm	+
MH-1070	8Fr PVC - Round	50cm	14cm	-
MH-1075	8Fr PVC - Round	50cm	14cm	+

Qty/Box: 50

Set Contents

- 50ml Evacuator
- Trocar Needle (in needle sets only)
- Round PVC Drain

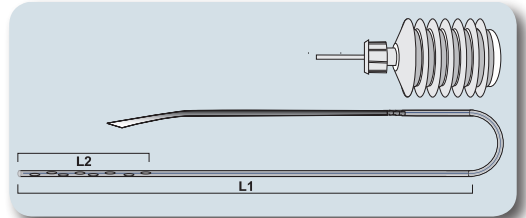

Flat-Type Tissue Drains

Code	Description
ME-0006	6mm
ME-0008	8mm
ME-0010	10mm
ME-0012	12mm
ME-0040	40mm

Qty/Box: 50

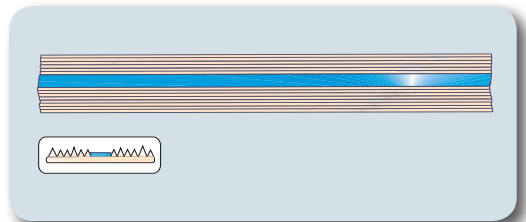

Multi-Lumen Drainage / Flushing Drains

Code	Description
MX-2500	50cm Dual Sump 7.5 x 6mm without filter
MX-2504	50cm Dual Sump 7.5 x 6mm with filter

Qty/Box: MX-2500: 50 MX-2504: 25

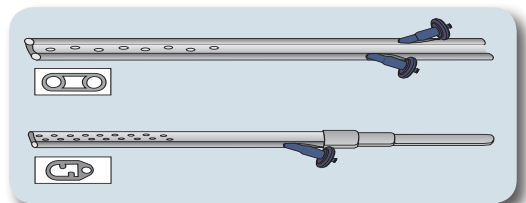

Biovac Drainage Bag

Code	Description
MD-0008	800ml Bag with Hanger

Qty/Box: 25

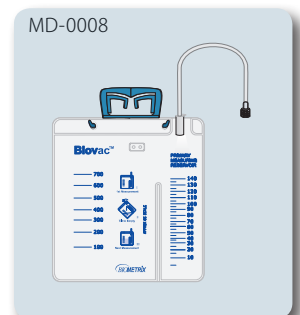

Gravitational Drainage Bag

Code	Description
DQ-X0800	Gravitational Drainage Bag

Qty/Box: 25

Set Contents

- 800ml Biovac Bag
- PVC Tube 2.0 x 3.75mm
- 3 Way Stopcock
- 4 Way Stopcock
- CLAVE[®] Luer-Activated Valve

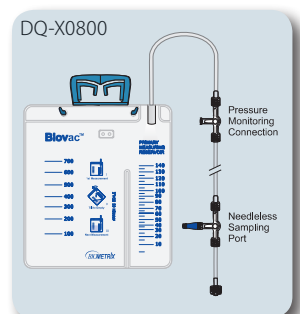

WOUND DRAINAGE

Gravitational Drainage Sets & Accessories

Gravitational Drainage Sets

Code	Description
NR-1620	16Fr round drain set
NR-1820	18Fr round drain set
NR-2020	20Fr round drain set
NR-2420	24Fr round drain set
NR-2820	28Fr round drain set
NR-3220	32Fr round drain set
NR-3620	36Fr round drain set
NR-4007	7mm flat drain set
NR-4010	10mm flat drain set

Qty/Box: 25

Set Contents

- 800ml Biovac Bag
- Silicone Thoracic Catheter

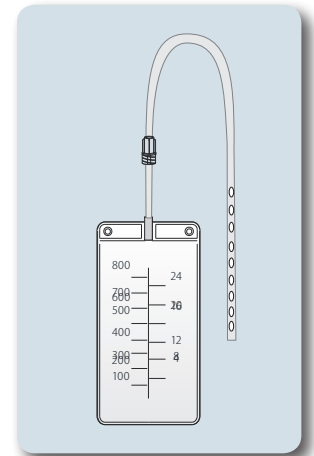

Peritoneal Drainage Sets

Code	Description	Qty/Box
MC-2000	Drainage Bag 2000cc	50
MC-2001	Peritoneal Drainage Set	25
MC-2002	Peritoneal Drainage Set, Luer Activated	25

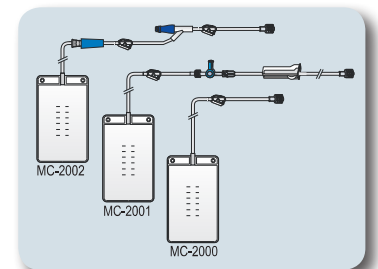

Vessel Loops

Code	Description
RV-X2121	Maxi White
RV-X2122	Maxi Blue
RV-X2123	Maxi Yellow
RV-X2124	Maxi Red
RV-X2131	Mini White
RV-X2132	Mini Blue
RV-X2133	Mini Yellow
RV-X2134	Mini Red

Qty/Box: 10 pouches per box. Each pouch contains 2x40cm stripes

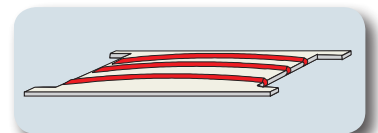

Silclamps

Code	Description
RVX-1212	5m Large Blue
RVX-1221	10m Medium White
RVX-1234	20m Small Red

Qty/Box: 50

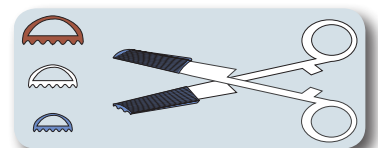

CSF DRAINAGE & ICP MONITORING SYSTEM

The Biometrix external CSF drainage and monitoring system is a closed drainage system of cerebrospinal fluid (CSF) that allows accurate pressure and flow rate monitoring.

Code	Description
IA-0020	CSF Drainage/ICP Monitoring Set
IQ-0010	Support System for CSF/ICP Set
IQ-0700	CSF/ICP Exchange Bag

Qty/Box: 25 IQ-0010: 1

Set Contents

- Measuring Plate
- 100ml Burette
- 800ml Exchange Bag
- Pressure Line
- Pressure Transducer

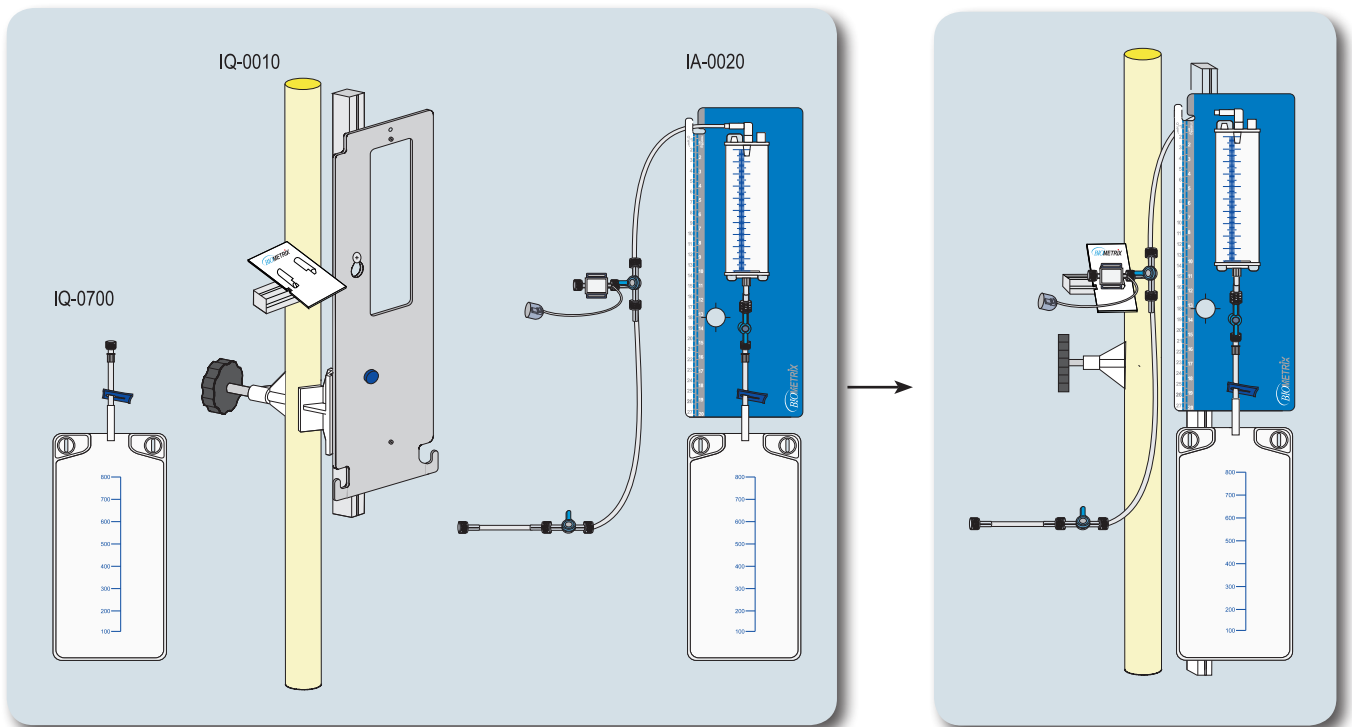

SUCTION

Suction Connecting Tubes

Code	Description	Qty/Box
TJ-P1200	200cm, Funnel-Funnel	50
TJ-P1300	300cm, Funnel-Funnel	30
TJ-P1350	350cm, Funnel-Funnel	30
TJ-P2210	200cm, Funnel-Fingertip	50
TJ-P2300	300cm, Funnel-Fingertip	30

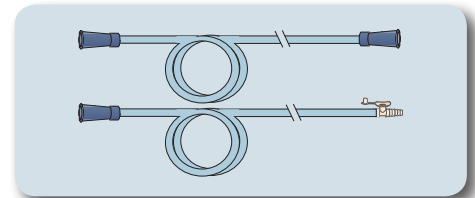

Yankauer Probes

Code	Description	Length	Total Suction Capacity*
TG-0010	Mini	180mm	29.4mm ²
TG-0020	Fine Tip	260mm	28.7mm ²
TG-0040	Maxi	262mm	112.2mm ²
TG-0050	Premier	265mm	67.2mm ²
TG-0060	Poole Large Bore	282mm	67.2mm ²
TW-0001	Finger Tip	-	-

Qty/Box: 50 TW-0001: 100 * Total size of openings

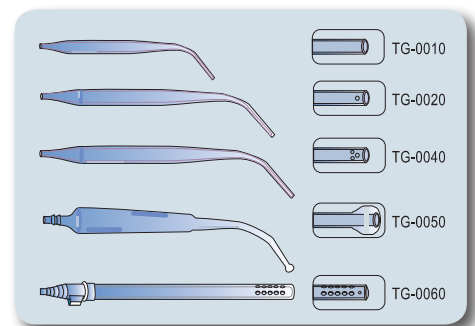

Yankauer Sets

Code	Description
TD-0105	200cm Tube with Yankauer Fine Tip Set
TD-0705	210cm Tube with Yankauer Flat Nozzle Set
TD-0805	200cm Tube with Yankauer Poole Suction Set
TD-0905	200cm Tube with Yankauer Premier Set
TD-X0405	300cm Tube with Yankauer Maxi Set
TD-X0505	300cm Tube with Yankauer Mini Set
TD-X0601	300cm Tube with Yankauer Large Bore Set

Qty/Box: 30 TD-X0601: 15

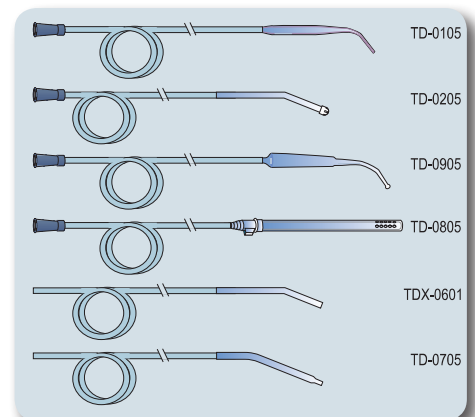

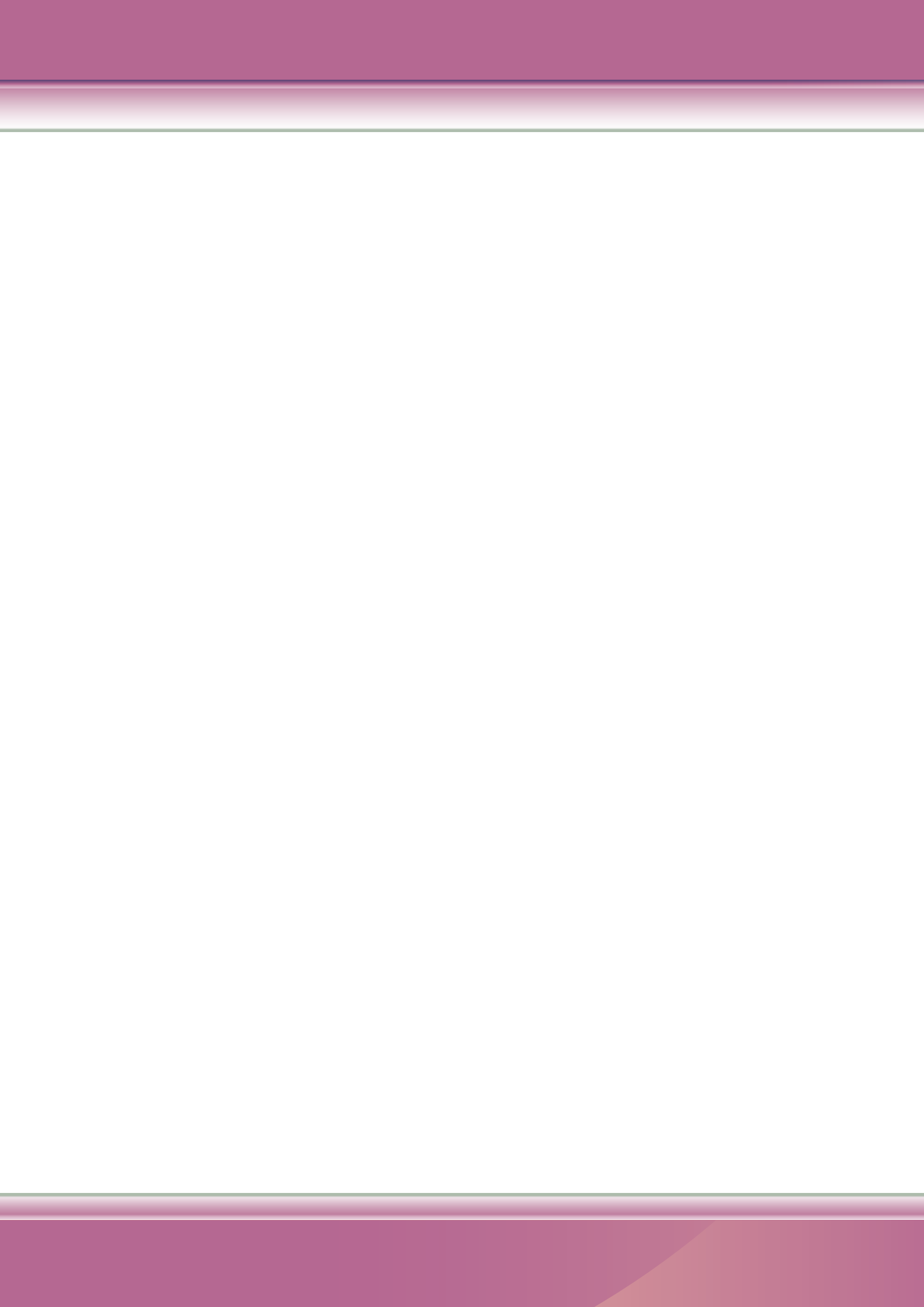

BIOMETRIX CPT

GENERAL SURGERY PACKS

ORTHOPEDIC PACKS

UROLOGY PACKS

LAPAROSCOPY PACKS

OBSTETRIC & GYNECOLOGY PACKS

HEART SURGERY PACKS



GENERAL SURGERY PACKS

Biometrix's innovative and fully customized custom procedure trays comply with physician's specifications, ensuring the highest level of performance and reliability, during procedures at healthcare facilities and cath labs.

Committed to quality solutions, the tray includes the complete product portfolio of sterile single-use components, from precision devices to draping systems and accessories.

The tray enables you to offer immediate treatment in a completely sterile environment, addressing the major concerns of fluid control, infection, and patient and surgeon safety.

Universal Pack

Code	No.	Bill of Materials	Qty.
RY-5023	1	Table Cover 150 x 250cm	1
	2	Mayo Cover 80 x 140cm	1
	3	Hand Towels	4
	4	Side Drapes 75 x 100cm	2
	5	Foot Drape 170 x 200cm	1
	6	Head Drape 240 x 150cm	1
	7	O.P. Tape 10 x 50cm	1

Qty/Box: 10

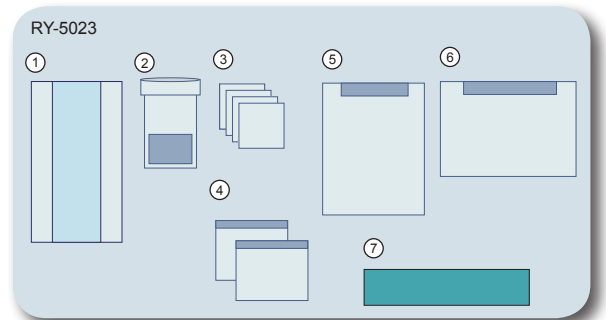

Minor Surgery Pack

Code	No.	Bill of Materials	Qty.
RY-5020	1	Drape 50 x 60cm	1
	2	Gauze Sponge 7.5 x 7.5cm	5
	3	Cup 60cc	1
	4	Cotton Wool Ball	5

Qty/Box: 25



GENERAL SURGERY PACKS

Laparotomy Kit

Code	No.	Bill of Materials	Qty.
DY-5040	1	Mayo Cover 80X140cm	1
	2	Table Cover 150X250cm	1
	3	Laparotomy Drape with Steridrape	1
	4	Diathermy Pouch 45X50cm	2

Qty/Box: 5

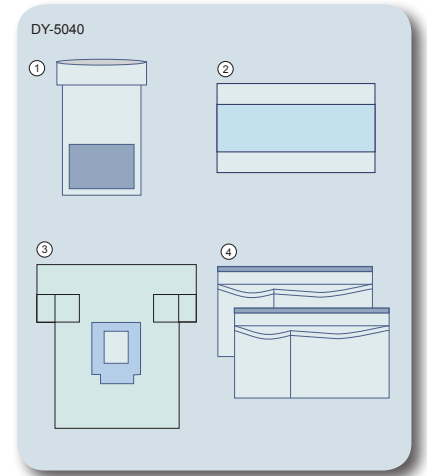

Abdominal Lithotomy Kit

Code	No.	Bill of Materials	Qty.
DY-5041	1	Mayo Cover 80X140cm	1
	2	Table Cover 150X250cm	1
	3	Drape 50x50cm with 5cm adhesive strip	1
	4	Abdominal Lithotomy Drape with Steridrape	1
	5	Diathermy Pouch 45X50cm	2

Qty/Box: 5

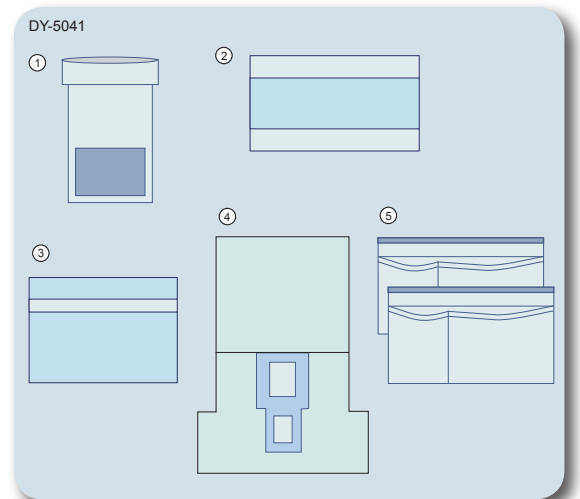

ORTHOPEDIC PACKS

Arthroscopy Pack

Code	No.	Bill of Materials	Qty.
DY-5005	1	Table Cover 100 x 137cm	1
	2	Arthroscopy Drape 228 x 300cm	1
	3	Camera Cover 15 x 236cm	1
	4	Reinforced Gown, Large	2
	5	Stockinette 30 x 60cm with Elastic Band	2
	6	3.0m Suction Tube F/F	1
	7	Arthroscopy Large Bore Irrigation Set	1

Qty/Box: 9

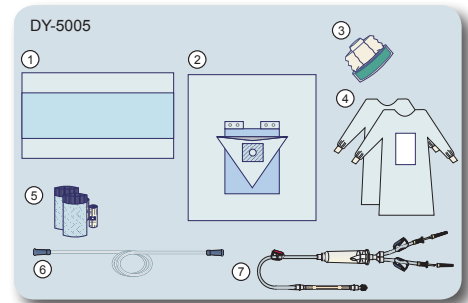

Extremity Pack

Code	No.	Bill of Materials	Qty.
DY-5006	1	Table Cover 137 x 180cm	2
	2	Extremity Drape 228 x 300cm	1
	3	Drape 100 x 120 with Adhesive Strip	1
	4	Foot Drape 170 x 200cm with Adhesive Strip	1
	5	Hand Towel 40 x 40cm	6
	6	Diathermy Pouch 35 x 43cm	1
	7	O.P. Tape 50 x 10cm	2
	8	Stockinette 40 x 100 cm with O.P. Tape	1

Qty/Box: 6

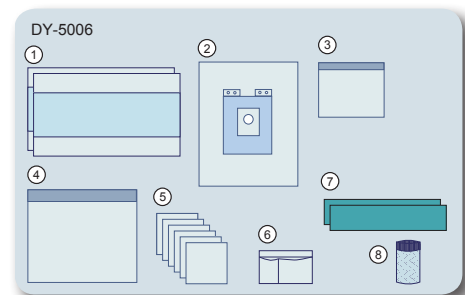

Foot Pack

Code	No.	Bill of Materials	Qty.
DY-5007	1	Table Cover 137 x 180cm	1
	2	Side Drape 75 x 100cm	1
	3	Foot Drape 170 x 200cm with Adhesive Strip	1
	4	Extremity Drape 228 x 300cm	1
	5	Hand Towel	6

Qty/Box: 10

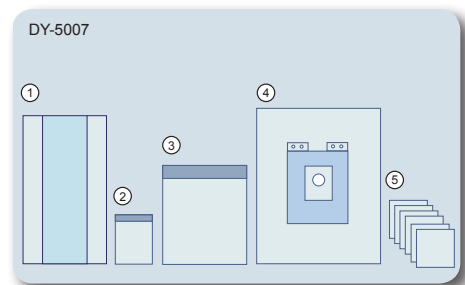

ORTHOPEDIC PACKS

Total Hip Replacement Pack

Code	No.	Bill of Materials	Qty.
DY-5009	1	Table Cover 100 x 137cm	2
	2	U Drape 220 x 250cm	1
	3	Stockinette 30 x 60cm with Elastic Band	1
	4	Diathermy Pouch 35 x 45cm	1
	5	3.0m Suction Tube F/F	1

Qty/Box: 9

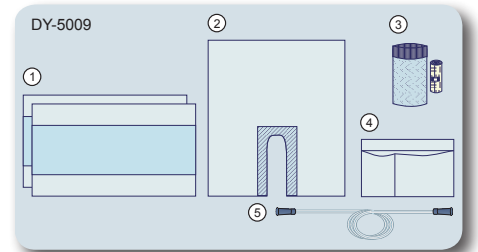

Total Hip Pack

Code	No.	Bill of Materials	Qty.
DY-8000	1	Table Cover 150 x 250cm	2
	2	Hip Drape with Pouches	1
	3	Stockinette 40 x 100cm with O.P. Tape	1
	4	Diathermy Pouch 35 x 43cm	1
	5	Blade #23	3
	6	Needle Counter	1
	7	Tip Cleaner	1
	8	Electrosurgical Pencil	1
	9	Gown Reinforced XL	3
	10	Lap Sponge 45x45-4 X-Ray	10
	11	Tray	1

Qty/Box: 3

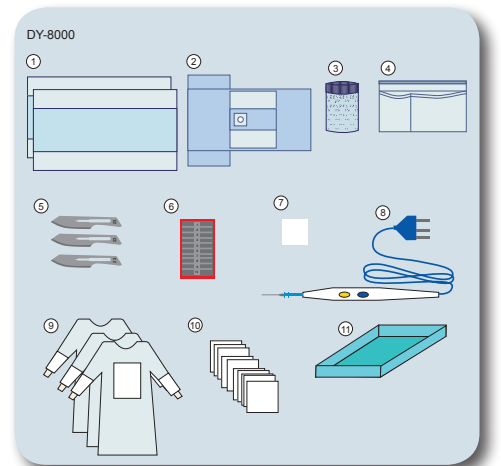

ORTHOPEDIC PACKS

Vertical Pack

Code	No.	Bill of Materials	Qty.
DY-8001	1	Table Cover 150 x 250cm	2
	2	Vertical Drape 320x245cm	1
	3	Blade #15	1
	4	Drape 90x100cm	1
	5	Blade #23	1
	6	Syringe 50cc Irrigation	1
	7	Skin Marker	1
	8	Electrosurgical Pencil	1
	9	Mayo Cover 80 x 140 cm	1
	10	Gown Reinforced XL	2
	11	Lap Sponge 45x45-4 X-Ray	10
	12	Tray	1

Qty/Box: 4

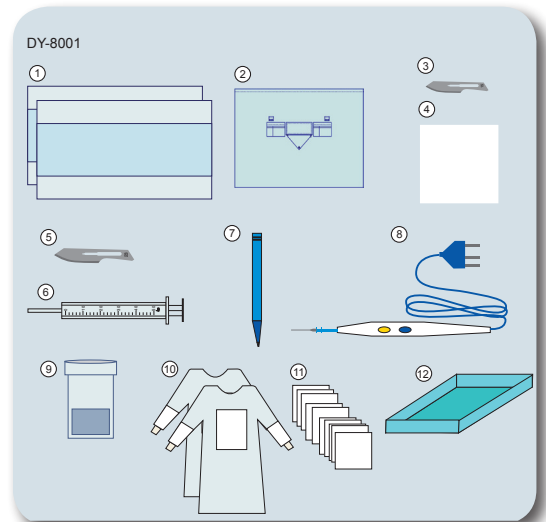

Total Knee Pack

Code	No.	Bill of Materials	Qty.
DY-8002	1	Table Cover 150 x 250cm	2
	2	Stockinette 30 x 60 cm with Elastic Band	1
	3	Diathermy Pouch	1
	4	Blade #23	1
	5	Needle Counter	1
	6	Tip Cleaner	1
	7	Electrosurgical Pencil	1
	8	Gown Reinforced XL	3
	9	Extremity Drape 228x300cm	1
	10	Lap Sponge 45x45-4 X-Ray	10
	11	Tray	1

Qty/Box: 4

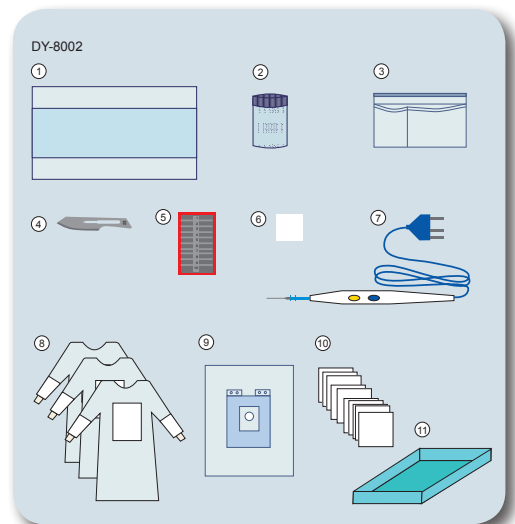

UROLOGY PACKS

TUR Pack

Code	No.	Bill of Materials	Qty.
DY-5010	1	Table Cover 137 x 150cm	1
	2	TUR Drape 180 x 240cm	1

Qty/Box: 16

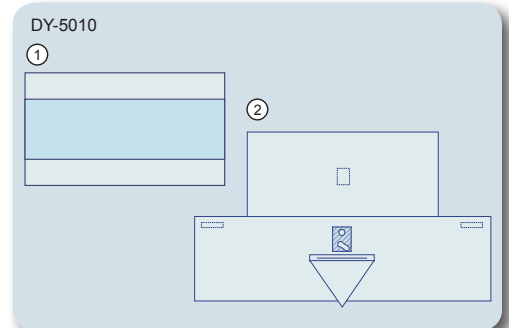

Urology Pack

Code	No.	Bill of Materials	Qty.
DY-5011	1	TUR Irrigation Set	1
	2	TUR Drape 180 x 240cm	1

Qty/Box: 9

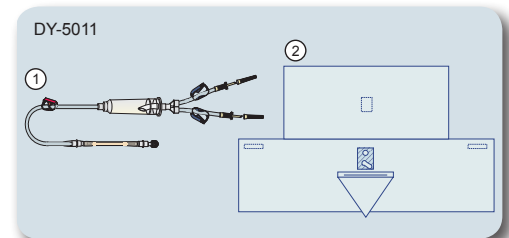

Lithiasis Pack

Code	No.	Bill of Materials	Qty.
DY-5022	1	TUR Drape 180 x 240cm	1
	2	Reinforced Gown, Medium	2
	3	Arm Sleeve 25 x 50cm	2
	4	Infusion Set Vented	1
	5	Bowl 250cc	2
	6	Cup 60cc	1

Qty/Box: 9

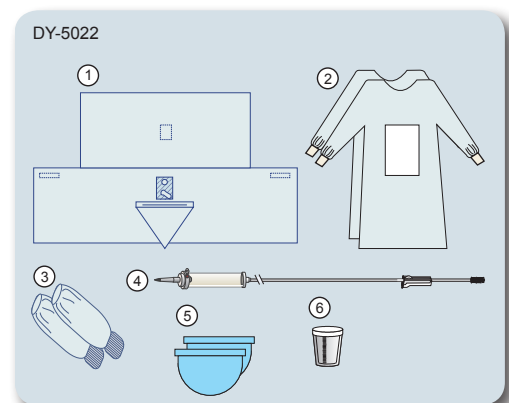

UROLOGY PACKS

TUR Pack

Code	No	Bill of Materials	Qty.
DY-5019	1	Table Cover 100 x 137cm	2
	2	Reinforced Gown "XL"	2
	3	TUR Drape 180 x 240cm	1
	4	TUR Irrigation Set	1
	5	Forceps	2
	6	20cc Syringe Luer F./F.	1
	7	300cm Suction Set	1
	8	Gauze Ball 45mm	10
	9	Gauze Sponge 10 x 10cm	10
	10	Bowl 250cc	2
	11	Emesis Basin 700cc	2

Qty/Box: 6

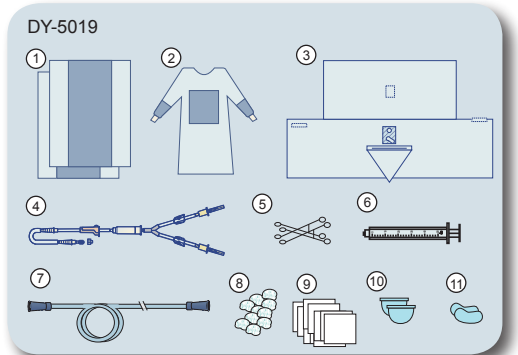

TUR Irrigation Sets

Code	Description	Qty/Box
DM-0201	Double-Lead TUR	50
DM-0250	Ureteroscopy Irrigation System	30
DM-0102	Single-Lead TUR	25
DQ-0430	Urethral Drain Adaptor	100

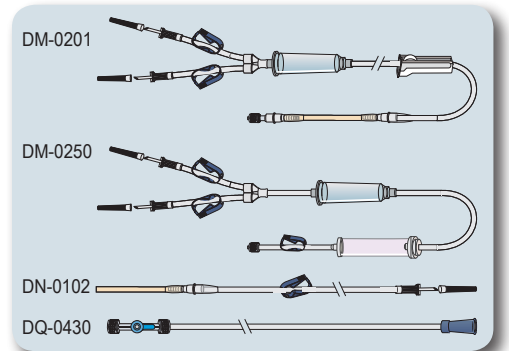

OBSTETRICS GYNECOLOGICAL PACKS

Delivery Packs

Code	No.	Bill of Materials	Qty.
RY-5015	1	Table Cover 137x150cm	1
	2	Standard Gown XL	1
	3	Legging 45x100cm	2
	4	Drape 50x75cm with Adhesive Strip	1
	5	Cup 100cc	1
	6	Drape 50x60cm	2
	7	Tray	1
	8	Under Buttocks Drape	1
	9	Gauze Sponge 10x10cm	20
	10	Umbilical Cord Clamp	1
	11	Hand Towel	2
	12	Baby Towel	1
	13	Absorbent Pad	4

Qty/Box: 10

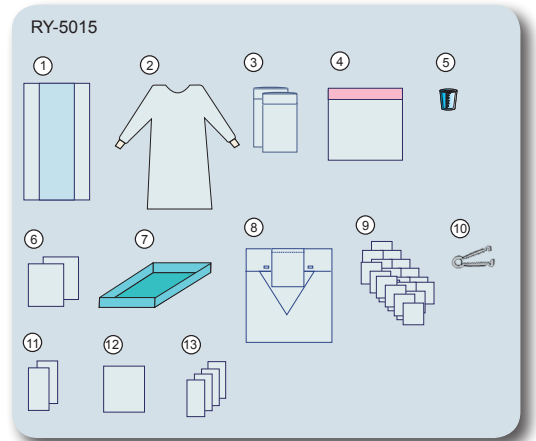

Gynecological Pack

Code	No.	Bill of Materials	Qty.
RY-5016	1	Table Cover 137x180cm	1
	2	Under Buttocks Drape	1
	3	Lithotomy Drape	1
	4	Hand Towel	1
	5	Absorbent Drape 50x50cm with Adhesive Strip	1

Qty/Box: 8

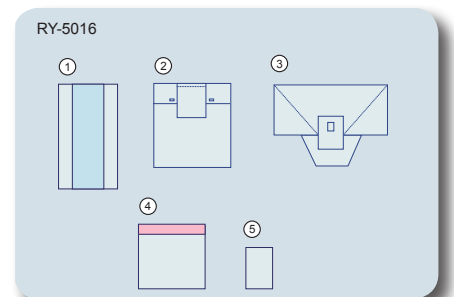

OBSTETRICS GYNECOLOGICAL PACKS

C-Section Packs

Code	No.	Bill of Materials	Qty.
RY-5050	1	C-Section Drape	1
	2	Lap Sponge 45x45 X-Ray	20
	3	Electrosurgical Pencil	1
	4	Suction Tube 300cm F/F	1
	5	Suction Catheter 12Fr	1
	6	Table Cover 137x100cm	1
	7	Dressing	1
	8	Blade #23	2
	9	Light Handle Cover	3
	10	Reinforced Gown XL	3
	11	Needle Counter	1
	12	Diathermy Pouch 35 x 43 cm	1

Qty/Box: 4

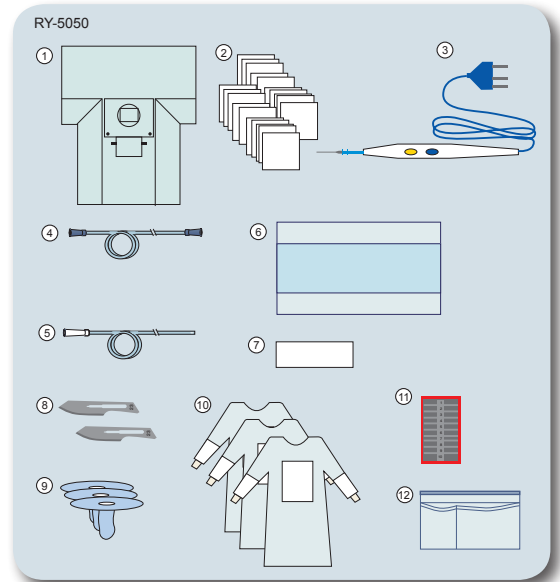

Code	No.	Bill of Materials	Qty.
RY-5060	1	C-Section Drape	1
	2	Skin Stapler	1
	3	Blade #10	1
	4	Blade #20	1
	5	Table Cover 150x250cm	1
	6	Combi Stopper Red	1
	7	Electrosurgical Pencil	1
	8	Light Handle Cover	2
	9	Tip Cleaner	1
	10	Diathermy Pouch 35 x 43 cm	1
	11	Lap Sponge 45x45 X-Ray	20
	12	Mayo Cover 80 x 140 cm	1
	13	Suction Tube 200cm with Poole Suction Unit	1
	14	Hypodermic Needle 18Gax1.5"	1
	15	Needle Counter	1
	16	Syringe 2cc L	1

Qty/Box: 5

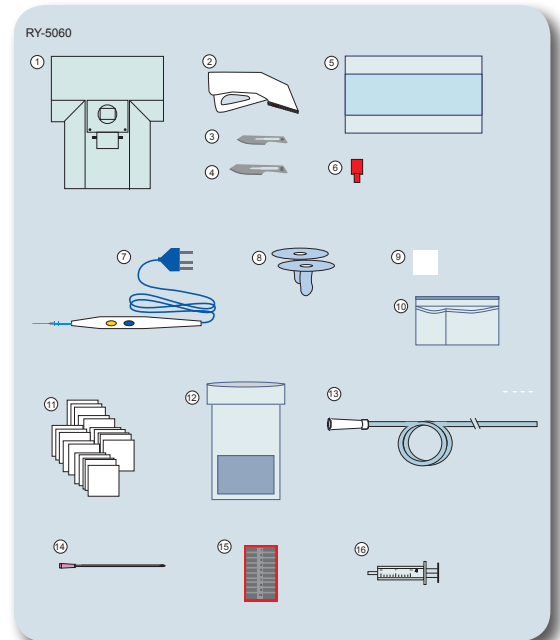

HEART SURGERY PACKS Pediatrics

Heart Surgery Pack

Code	No.	Bill of Materials	Qty.
BY-5024	1	Heart Surgery Drape 270x310cm Pediatric	1
	2	Bowl 1000cc	1
	3	Bowl 250cc	2
	4	Cup 100cc	1
	5	Tip Cleaner	1
	6	Suction Tube F/F 300cm	2
	7	Lap Sponge 30X30-4 X-Ray	10
	8	Gauze Sponge 10x10cm 12ply	5
	9	Gauze 10X10cm X-Ray 12Ply	20
	10	Emesis Basin 700cc	1
	11	Tray	1
	12	Needle Counter	1
	13	Syringe 50cc Irrigation	2
	14	Syringe 20cc Luer (B/D)	2
	15	Syringe 10cc Luer	1
	16	Thoracic Catheter 20Fr Straight with Connector	1
	17	Hand Towel	1
	18	Waste Bag 50x60cm	1
	19	Blade #15	1
	20	Blade #11	2
	21	Instruments Organizer	1
	22	Infusion Set Vented	1
	23	Snars 8Fr	7
	24	Snars 12Fr	2
	25	Diathermy Pouch 35X43cm	2

Qty/Box: 5

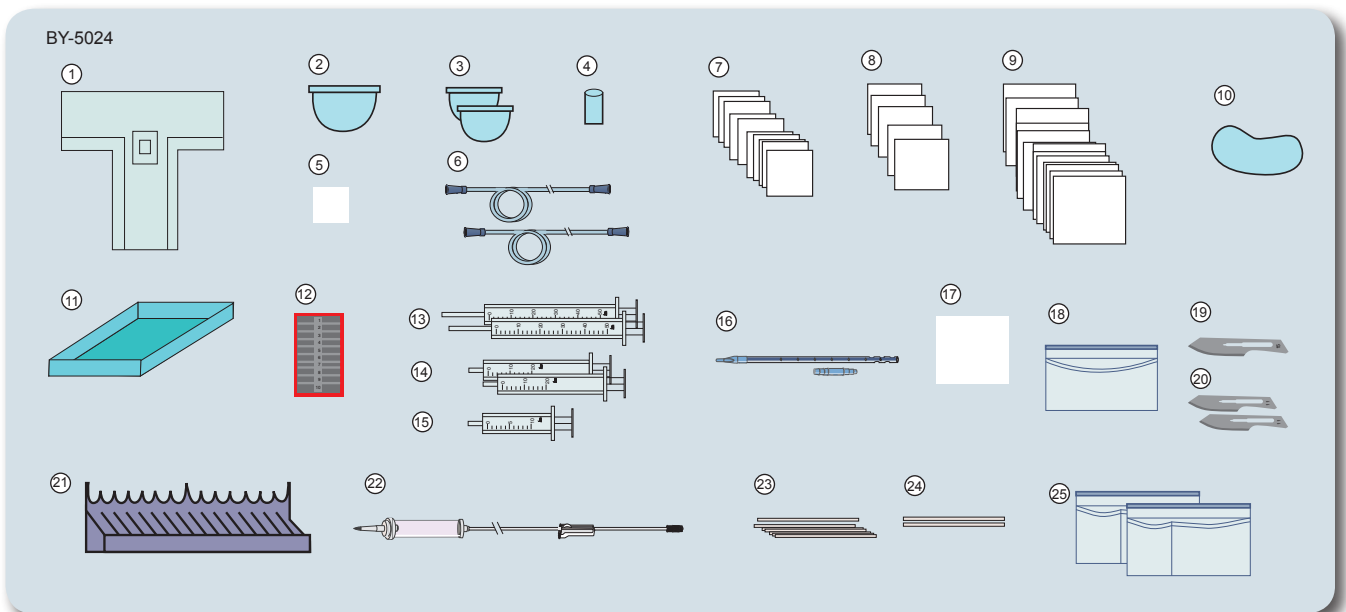

HEART SURGERY PACKS Adults

Heart Surgery Pack

Code	No.	Bill of Materials	Qty.
BY-5050	1	Heart Surgery Drape 274x320cm	1
	2	Reinforced Gown XL	1
	3	Reinforced Table Cover 137x180cm	1
	4	Table Cover 150x250cm	1
	5	Yankauer	1
	6	Mayo Cover 80 x 140 cm	2
	7	Drape 100x120cm	10
	8	Bowl 500cc	2
	9	Bowl 250cc	6
	10	High Capacity Chest Drainage System	1
	11	Tip Cleaner	1
	12	Suction Tube 350cm F/F	1
	13	Electrosurgical Pencil	1
	14	Lap Sponge 45x45cm X-Ray	10
	15	Lap Sponge 30x30cm X-Ray	10
	16	Gauze Sponge 10x10cm X-Ray	30
	17	Emesis Basin 700cc	2
	18	Bowl 1500cc	2
	19	Irrigation Syringe 50cc	1
	20	Syringe 50cc LL	1
	21	Syringe 10cc L	2
	22	Syringe 20cc L	2
	23	Thoracic Catheter 32Fr Straight	1
	24	Thoracic Catheter 32Fr Right Angle	1
	25	Cotton Towels	10
	26	Waste Bag 50 x 60	1
	27	OP Tape	2
	28	Tray	2

Qty/Box 1

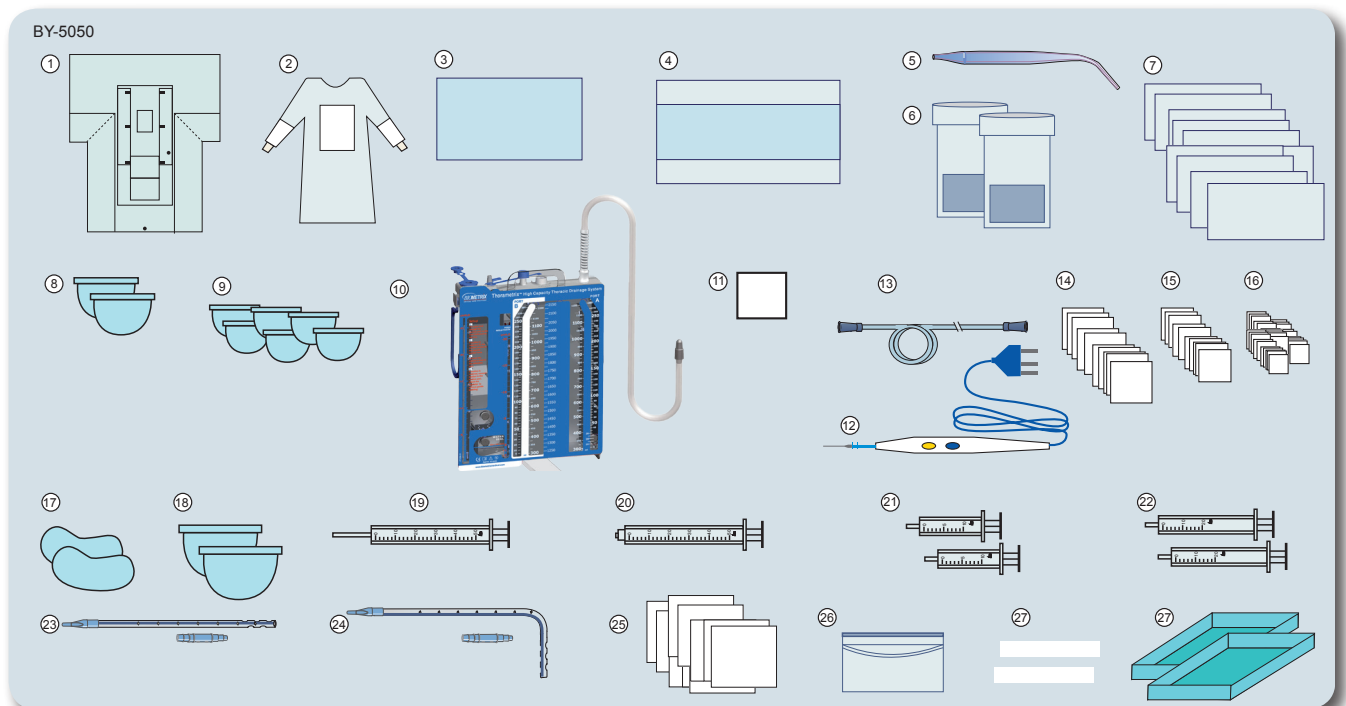

Conversion Table: French Size/Milimeter/Inches/Actual Size

French Size	Milimeter	Gauge	Inches
	0.10	36	0.004
	0.13	35	0.005
	0.18	34	0.007
	0.20	33	0.008
	0.23	32	0.009
	0.25	31	0.010
	0.30	30	0.012
1	0.33	29	0.013
	0.36	28	0.014
	0.41	27	0.016
	0.46	26	0.018
	0.51	25	0.020
	0.56	24	0.022
	0.64	23	0.025
2	0.66	-	0.026
	0.71	22	0.028
	0.81	21	0.032
	0.89	20	0.035
3	1.00	-	0.039
	1.07	19	0.042
	1.27	18	0.050
4	1.35	-	0.053
	1.50	17	0.059
	1.65	16	0.065
5	1.68	-	0.066

French Size	Milimeter	Gauge	Inches
	1.83	15	0.072
6	2.00	-	0.079
	2.11	14	0.083
7	2.34	-	0.092
	2.41	13	0.095
8	2.67	-	0.105
	2.77	12	0.109
9	3.00	-	0.118
	3.05	11	0.120
10	3.33	-	0.131
	3.40	10	0.134
11	3.66	-	0.144
	3.75	9	0.148
12	4.00	-	0.158
	4.19	8	0.165
13	4.32	-	0.170
	4.57	7	0.180
14	4.67	-	0.184
	4.95	-	0.195
15	5.00	-	0.197
	5.16	6	0.203
16	5.33	-	0.210
	5.50	-	0.216
18	5.94	-	0.234

Actual French Size	1 Fr.	2 Fr.
	•	•
3 Fr.	4 Fr.	5 Fr.
•	•	•
6 Fr.	7 Fr.	8 Fr.
•	•	•
9 Fr.	10 Fr.	11 Fr.
•	•	•
12 Fr.	13 Fr.	14 Fr.
•	•	•
15 Fr.	16 Fr.	18 Fr.
•	•	•

SURGICAL DRAPES AND COVERS

GENERAL SURGERY DRAPES & COVERS

OPHTHALMIC SURGERY DRAPES

ORTHOPEDIC SURGERY DRAPES

DELIVERY DRAPES

UROLOGY DRAPES

LAPAROSCOPY DRAPES

GENERAL SURGERY DRAPES & COVERS

Table Cover

Code	Specifications
DY-0003	100 x 137cm
DY-0005	150 X250cm
DY-0009	137 x 180cm
DY-0010	137 x 150cm

Qty/Box: 50

Material:

- 2 layer laminated fabric

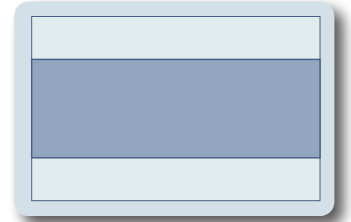

Mayo Cover

Code	Specifications
DY-0004	80 x 140cm

Qty/Box: 25

Materials:

- Polyethylene ● Viscose (absorbent)

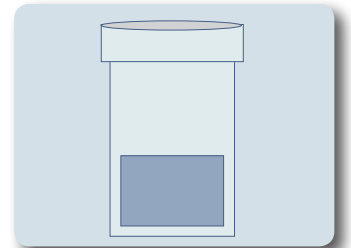

Leggings

Code	Specifications
DY-0008	37.5 x 100cm
DY-0015	45 x 100cm (set of 2)

Qty/Box: 50

Material:

- 2 layer laminated fabric

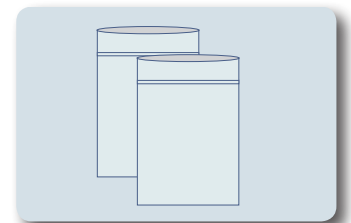

SURGICAL DRAPES & COVERS

GENERAL SURGERY DRAPES & COVERS

Fluid Collection Pouch

Code	Specifications
DY-1006	Fluid Collection Pouch 50 x 55cm

Qty/Box: 50

Set Contents

- Plastic mesh sieve
- Drainage port
- Adhesive strip

Materials:

- Clear Film

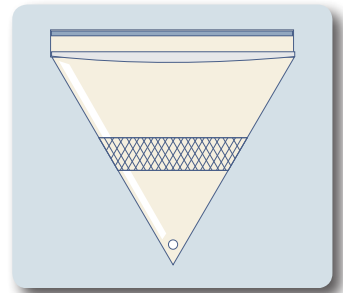

Camera Cover

Code	Specifications
DY-1001	15 x 236cm

Qty/Box: 50

Material:

- LDPE
- transparent natural
- antistatic PE
- color: white

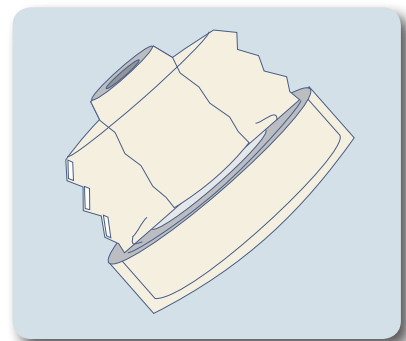

Diathermy Pouch

Code	Specifications
DY-0002	Diathermy Pouch 35 x 43cm
DY-0013	Diathermy Pouch 50 x 45cm

Qty/Box: 50

Material:

- LDPE
- color: blue

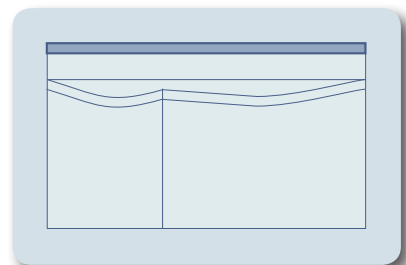

OPHTHALMIC SURGERY DRAPES

Ophthalmic Drapes

Code	Description	Qty/Box
OY-3002	Drape 150 x 250cm, oval fenestration area with two Fluid Collection Pouches	15
OY-3005	Drape 150 x 250cm, oval fenestration area with two Fluid Collection Pouches and Drape 40 x 40cm Clear with perforation, fenestration area circle diameter 6.2cm	25
OY-3004	Drape 100 x 140cm, fenestration area 3.2 x 6.2cm with Fluid Collection Pouch	50
OY-3006	Drape 100 x 140cm, fenestration area 3.2 x 6.2cm with Fluid Collection Pouch and Drape 40 x 40cm Clear with perforation, fenestration area circle diameter 6.2cm	50

Description:

- Adhesive area: 15 x 15cm

Material:

- SMS - Spunbond Meltblow Spunbond fabric

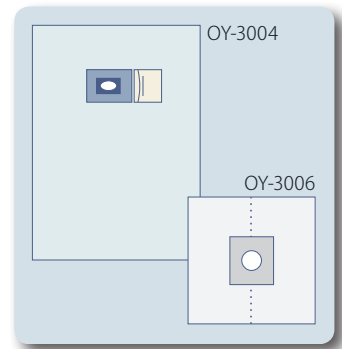
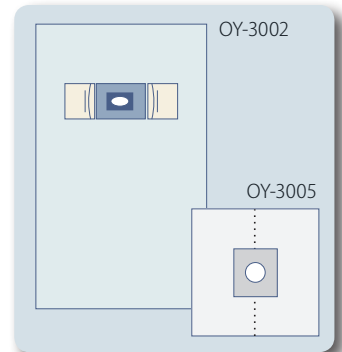

Ophthalmic Drape 50 x 50cm

Code	Description	Qty/Box: 50
OY-3003	Drape 50 x 50cm, fenestration area circle diameter 6.2cm	
OY-3008	Drape 50 x 50cm, with Fluid Collection Pouch	

Description:

- Adhesive area: 9 x 11cm

Material:

- 2 layer laminated fabric

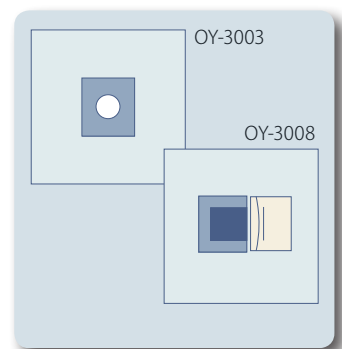

SURGICAL DRAPES & COVERS

ORTHOPEDIC SURGERY DRAPES

Extremity Drape

Code	Specifications
DY-3003	228 x 300cm

Qty/Box: 15

Description:

- Absorbent area: 80 x 100cm
- Fenestration Diameter: 6.2cm
- Flexible fenestration area: 22 x 22cm
- Tube holders

Material:

- Spunlaced fabric + Laminated Fabric

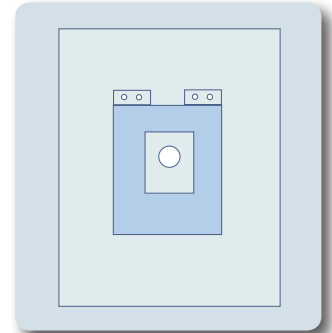

Arthroscopy Drape

Code	Specifications
DY-3004	228 x 300cm

Qty/Box: 12

Description:

- Absorbent area: 80 x 100cm
- Fluid Collection Pouch
- Flexible fenestration area: 22 x 22 cm
- Tube holder

Material:

- Spunlaced fabric + Laminated Fabric

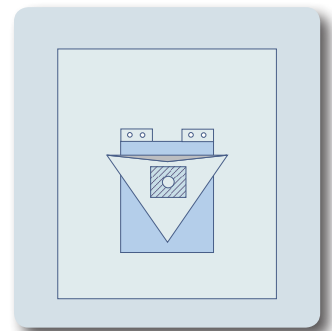

U-Drapes

Code	Specifications
DY-3008	220 x 250cm (Split 20x100cm)
DY-3009	150 x 250cm (Split 20x100cm)
DY-3011	220 x 250cm with fluid collection pouch
DY-3015	150 x 160cm (20x60cm) Clear PE

Qty/Box: 25

Material:

- 2 layer laminated fabric

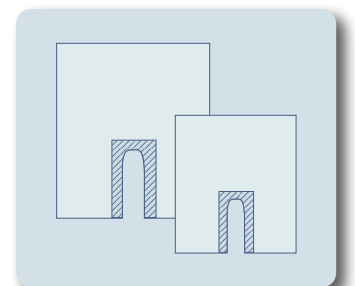

ORTHOPEDIC SURGERY DRAPES

Vertical Drape

Code	Specifications
DY-3006	Vertical Isolation Drape 320x245cm

Qty/Box: 20

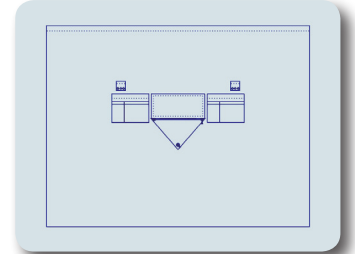

Stockinette

Code	Specifications
DY-0001	30 x 60cm with Elastic Band
DY-0014	40 x 100cm with O.P. tape

Qty/Box: 25

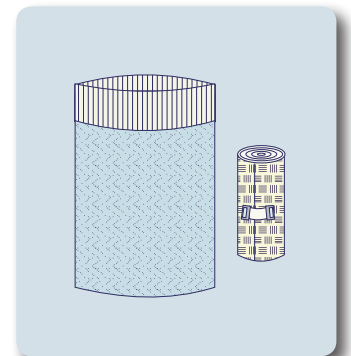

Shoulder Arthroscopy Drape

Code	Specifications
DY-3016	Shoulder Arthroscopy Drape 406 x 259 cm

Qty/Box: 10

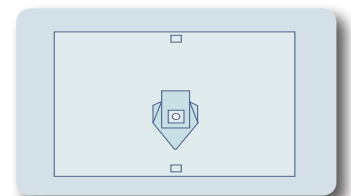

SURGICAL DRAPES & COVERS

GYNECOLOGY DRAPES

C-Section Drape

Code	Specifications
DY-3050	C-Section Drape 200x300x250cm

Qty/Box: 12

Description:

- Absorbent area 50 x 40cm
- Round Fluid Collection Pouch
- Tube Holders

Material:

- Spunlaced Fabric + Laminated Fabric

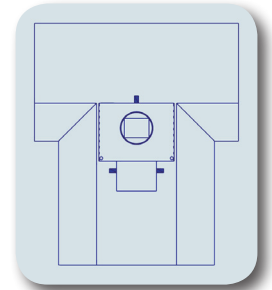

Underbuttocks Drape

Code	Specifications
RY-3010	Underbuttocks Drape 100x110cm with Fluid Collection Pouch

Qty/Box: 25

Material:

- Blue P.E., 70 micron
- Absorbent Material

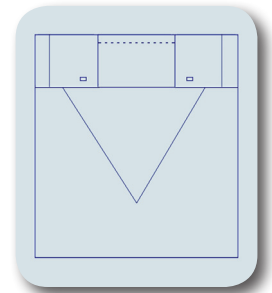

Code	Specifications
RY-3011	Underbuttocks Drape 100x110cm with Fluid Collection Pouch, Port and Net

Qty/Box: 25

Material:

- Blue P.E., 70 micron
- Absorbent Material

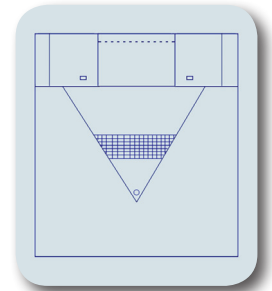

Code	Specifications
RY-3012	Underbuttocks Drape 100x110cm without pouch

Qty/Box: 25

Material:

- Blue P.E., 70 micron
- Absorbent Material

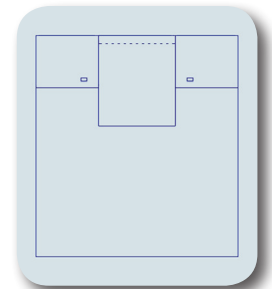

UROLOGY & LAPAROSCOPY DRAPES

Transurethral Resection Drape (TUR)

Code	Specifications
DY-3012	180 x 240cm with 45cm Extension Tube
DY-3013	180 x 240cm with 130cm Extension Tube

Qty/Box: 12

Description:

- Fenestration area: 2.5cm
- Integral Finger Cover
- Fluid Collection Pouch with Sieve and Drainage Port
- Integral Leggings
- Top Catheter Fenestration

Material:

- Spunlaced fabric

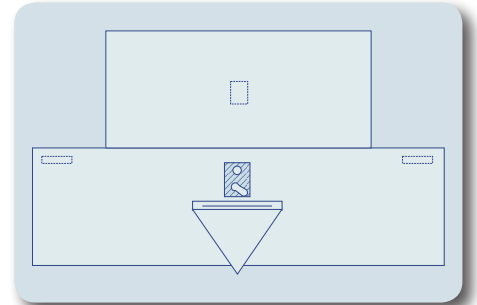

General Laparoscopy Drape

Code	Specifications
RY-3001	General Laparoscopy Drape 228 x 340 x 282cm

Qty/Box: 25

Description:

- Absorbent area
- 2 Diathermy Pouches
- Fenestration area: 6.2cm

Material:

- SMS

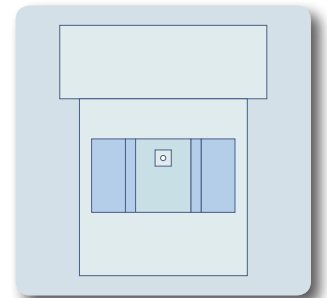

Gynecology Laparoscopy Drape

Code	Specifications
RY-3002	Gynecology Laparoscopy Drape 150 x 300cm

Qty/Box: 25

Description:

- Absorbent area
- 2 Adhesive areas: 15 x 24cm

Material:

- SMS

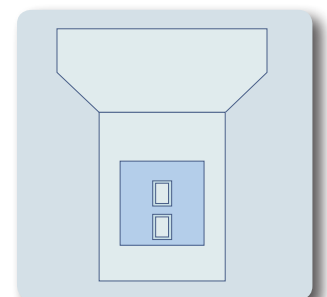

- Custom packs for laparoscopy available